

www.posh-factory.com

# POSH FACTORY

MANUFACTURING & DISTRIBUTING

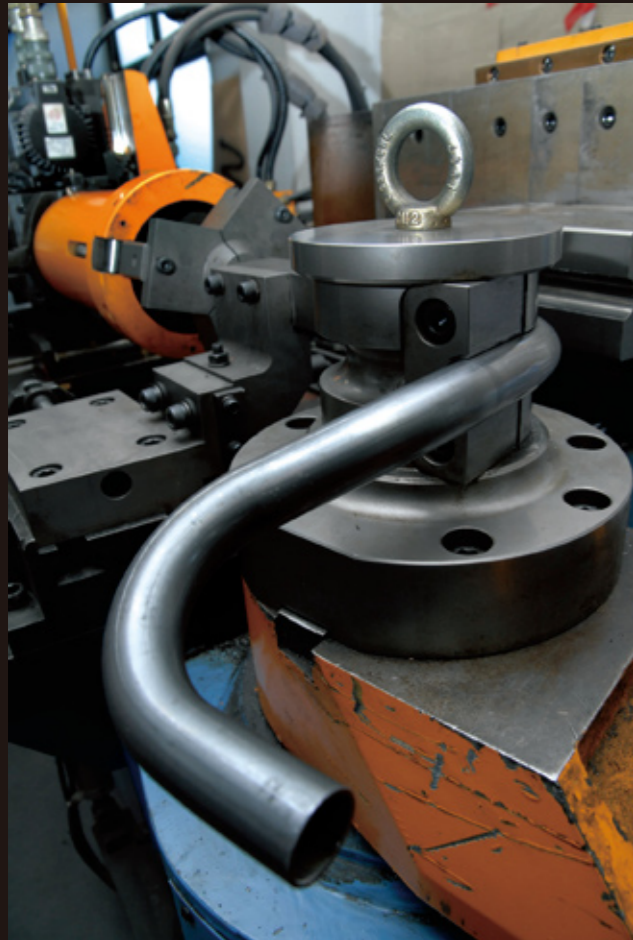

POSH FACTORY RACING



In a custom show



MOTOR CYCLE PARTS CATALOGUE VOL.2.0  
for HARLEY-DAVIDSON  
& Choppers

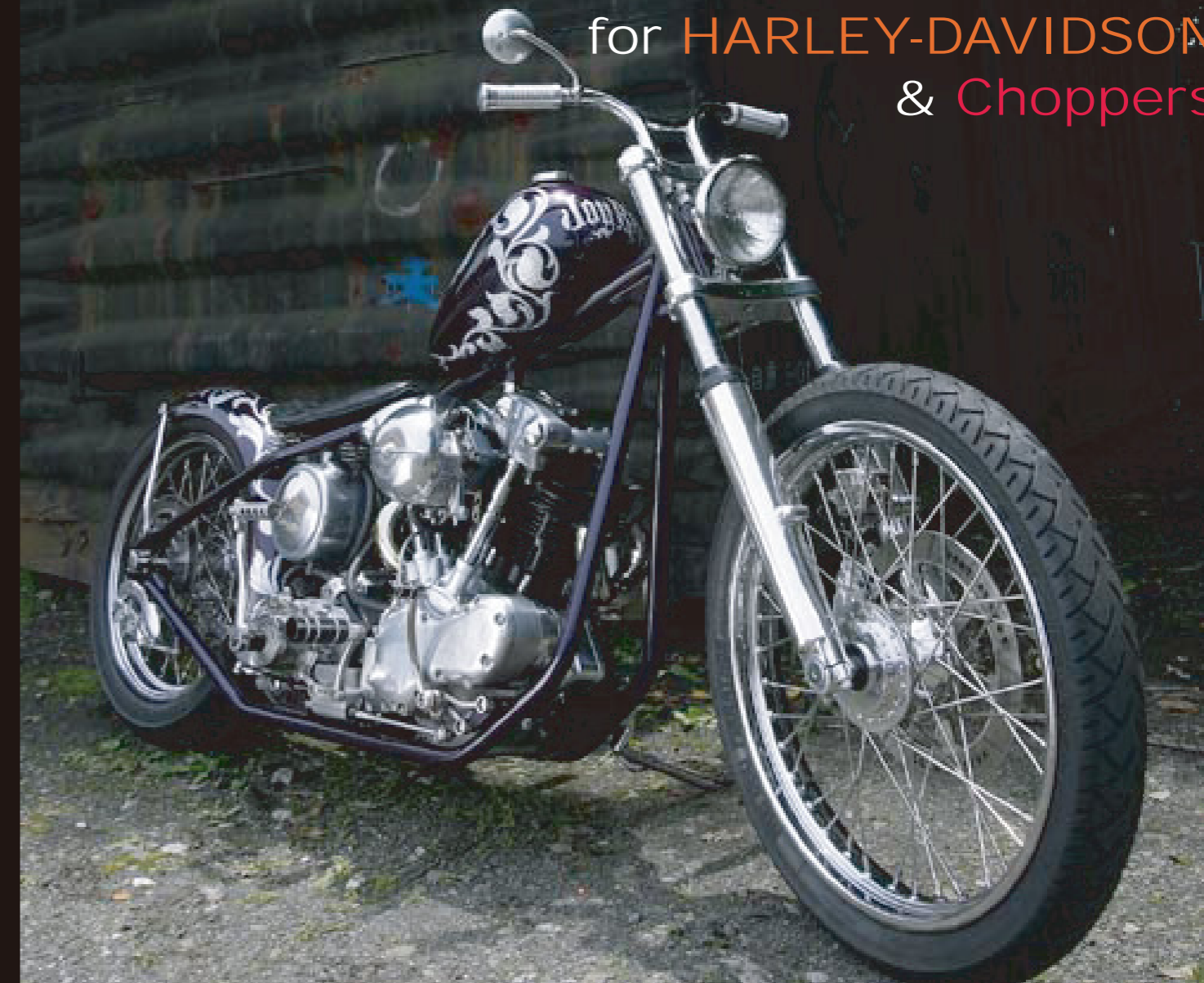

# POSH FACTORY

3-27-30 HANAKOGANEI KODAIRA-CITY TOKYO 187-0002 JAPAN

TEL +81-424-2123 FAX +81-424-2133

www.posh-factory.com

www.posh-factory.com

# PARTS for HARLEY DAVIDSON & CHOPPERS

# POSH

MOTORCYCLE PARTS

Vol.2.0

## CONTENTS

- P4-5 Custom by POSH FACTORY  
"JOY RIDE"
- P6-7  $\phi$ 41 Narrow Triple
- P8-9 1inch Internal Throttle,  
Billet Grip & Wires
- P10-11 7/8inch Internal Throttle, & Wires
- P12-13 1inch Bent Pipe & Wedding On Parts
- P14-15 TT Handle & Wire, Cotton Braided  
Ignition Wire & Miscs
- P16-17 1inch Mini Switch & 1Hole Miniswitch  
for 1inch Handlebar
- P18-19 7/8inch Miniswitch & 1Hole MiniSwitch  
for 1inch Handlebar
- P20-21 Adjustable Transmission Plate,  
Short Speed Meter Cable for 4Speed BT  
Low High LED Tail Light  
Adjustable Kickstand Stop  
Axle Paint Saver  
Early Barrel Grip  
Another Grip
- P22-25 Bent Pipes & Muffler Miscs
- P26-27 Mirror
- P28-29 Blim Type Turn Signal
- P30-31 Blim Type Turn Signal LED Type
- P32-33 Machined Type & Prism type Turn Signal
- P34 Fuel Hose, INSULOCK, One Way Valve  
Spiral Tube

---

### POSH Faith Brand

- P36-37 Basic Type, Classical Type, Machined type  
Turn Signal & Replacement Parts
- P38-39 Meter line
- P40-41 Head Light & Taillight
- P42-43 Reflector & Mirror
- P44-45 Universal Parts
- P46-47 Stainless Steel Bolts & Nuts

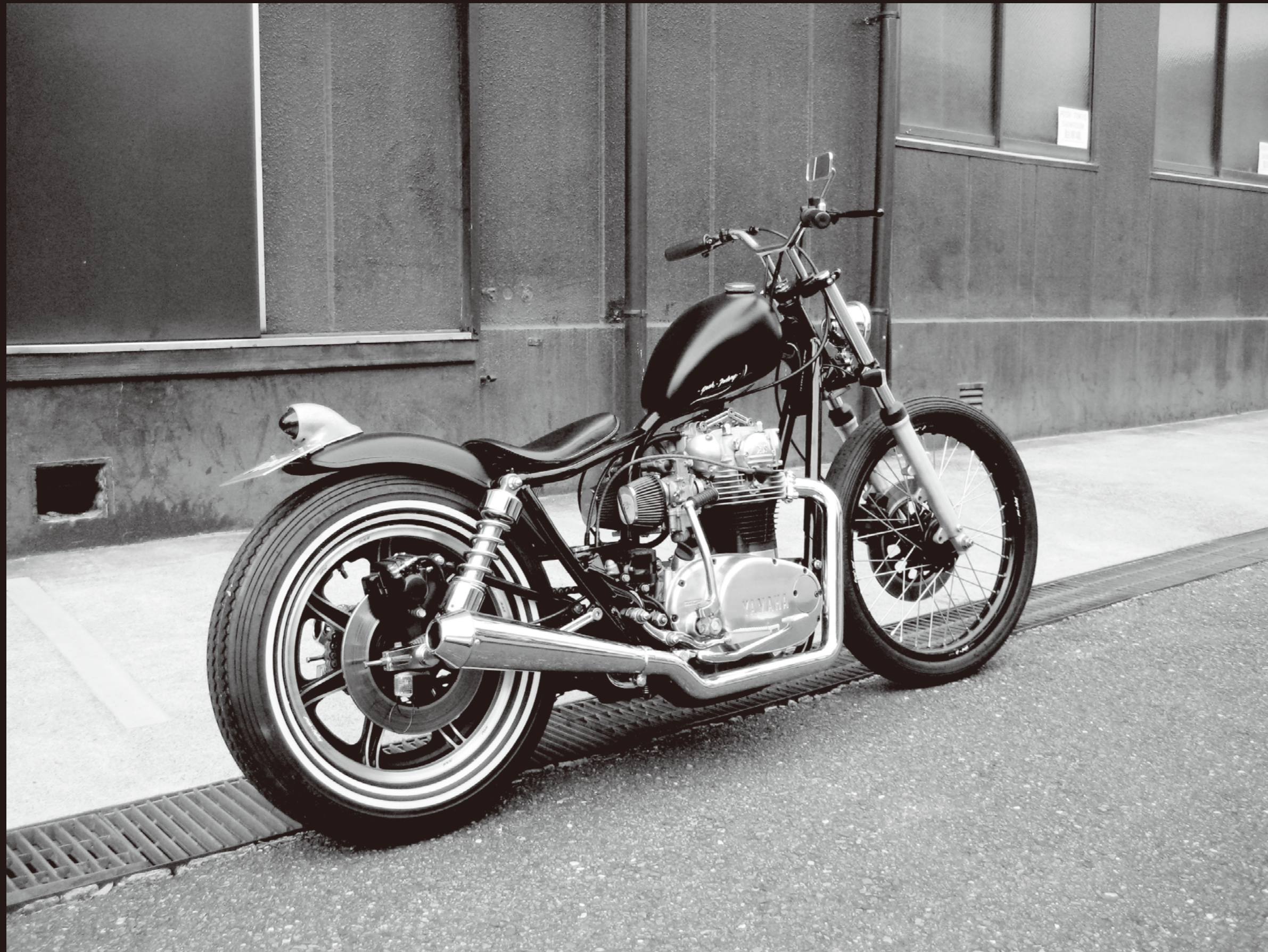

# POSH FACTORY "JOY RIDE"

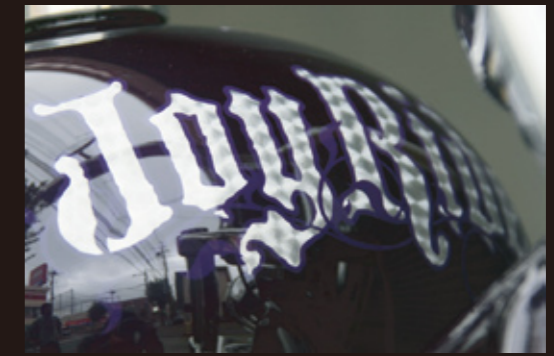

## Contained parts List

### [ Handle Area ]

1" bend pipe 80R [SS] #880150-50

Joint riser for welding on [SS] #880160

3" round mirror [modified] #880380

φ1 inch internal throttle kit [SS] #880371

Grip for φ1 inch internal throttle [S/A] #880371

Throttle cable for internal use [BK] #880275

11.5" front brake disk [concept model]

φ41 narrow glide triple tree [S/P] #882161

### [ Gas tank & Oil tank area ]

Petcock socket for welding on [SS] #880535

Oil tank [concept model]

### [ Peg & fender area ]

Stay collar for welding on [SS] #880100/880101

### [ Muffler area ]

φ45 120R bend pipe [SS]

φ45 55R bend pipe [SS]

Spread pipe [φ45mm → φ50.8SS] #850052

### [ Transmission area ]

Adjustable transmission plate #882100

### [ Other ]

Adjustable Kickstand stop #880800

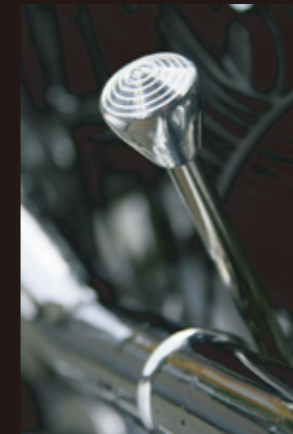
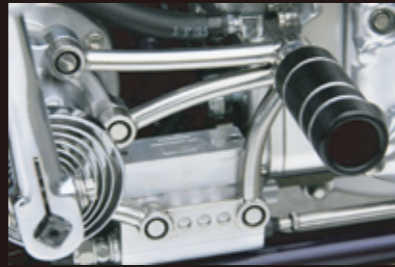

# φ 41 Narrow Triple

## φ 41 NARROW TRIPLE

- ◆ φ 41 narrow triple was finally put on the market spending long time and repeating making for trial purposes/test.
- It can be an installation of the disk brake of the reception desk and a bolt it on and by being able to narrow 59mm fork pitch compared with a wide glide of purity, and by building in parts of our specification.
- If it is 21 inches or 19-inch wheels, 11.5-inch disk rotors, and is an- adjustment of the production of the caliper support and the wheel collar etc. separately and the 41 narrow front fork reception after '49, it is possible to use it regardless of the age type.



φ 41 NARROW TRIPLE



OE Wide Glide



Picture1

Bolt it on required

- '00up Front Wheel Hub OEM43619-00/43610-00      21inch or 19inch Rims
- '00up Front Fork FXST OEM46004-00/46006-00 or FLT OEM46495-00/46497-00
- Performance Machine Inc. 4 Piston Calipers  
(Parts # 0053-2920-P or 0053-2920-CH or 0053-2920-B)



If you are installing the BT'36-'84 required Neck Cup Kit (Picture1)  
If you are installing the '88Up Softtail Frame Model required Internal Fork Stop



- ◆ It is related to the material, and triple upper and lower tree made by duralumin (A2017) and the axle shaft is made by chromium molybdenum steel(SCM435). It is stainless steels in the disk spacer and the collar. After right material in the right place necessity strength intimately is given by using stainless inch bolt made by DIAMOND.Eng(us) company for the installation bolt, corrosion resistance is designed considerably.
- ◆ finish also prepares three kinds standard(unprocessing beginning cutting down) and the show polish and polish black (anodized aluminum after polish)), it is possible to choose according to the favorite.

Part #	Finish	Axle Shaft	Sug.Retail
884160	Standerd	FXST	\$1,008.00
884161	Show Polish	FXST	\$1,050.00
884162	Polish Black	FXST	\$1,081.50
882160	Standerd	FLT	\$1,029.00
882161	Show Polish	FLT	\$1,071.00
882162	Polish Black	FLT	\$1,102.50

# φ 1 inch Internal Throttle Kit

Internal Throttle Kit is a throttle system to put wires through a pipe. This is the best item to make the appearance around the steering parts look sharp. Select the best one for you in consideration of the material and thickness of your handlebar.

### Characteristics

Duralumin 17S used for a slide barrel and WPC-MOS2 processing for the surface of the material reduce the slide friction. Also, the two made-in-Japan bearings in high quality in the slide barrel make very smooth control possible. The internal parts can be removed even while the kit is mounted, so wires can be easily removed or adjusted.

※WPC: A processing that can enhance the toughness and endurance of the material.

※MOS2: Molybdenum disulphide is inserted into the deeper part of a main material and re-crystallized. This processing enhances abrasion quality and reduces slide friction. Even when the main material is abraded away by friction, the layer of molybdenum disulphide spreads over the damaged spots and keeps its duration.

Part #	Handlebar Thickness	material	Sug.Retail
880370	1.6mm	Steel	\$299.25
880371	2.0mm	Steel	\$299.25
880375	1.5mm	Stainless Steel	\$325.50
880376	2.0mm	Stainless Steel	\$325.50

※ Regardless of a material of grips, this kit fits any grip for Harley-Davidson separated from a throttle corn.



### SLIDE BARREL ASSY



Duralumin 17S for the slide barrel and WPC and MOS2 processing for the surface of the material can curtail slide friction. Twominnature bearings with high accuracy and high performance actualize smooth control.



Stable stroke work is actualize even while running by inserting the inner sleeves into the handle bar and welding it directly to the handlebar

### KIT components



### TWIST SLEEVE ASSY



By using domestic ball bearing (removable, exchangeable) for the edge of inner sleeves and stabilizing it with bolts, smooth control without backlash in the radial and thrust direction is actualized.



You can remove the inner parts while attaching, so it makes easier for you to insert and adjust the wires after fixing the handlebars

- ◆ Deassembling after attaching to the handlebar is very easy, because the wire catch is made in the consideration of wire attachment, exchange, and grip up.
- ◆ Enhancement of quality of all component and distinctive inventions for reducing side friction actualize smooth control.
- ◆ The handle bar used now is cut, welded, and installed in a specified size.
- ◆ most in complete parts is designed to suppress the generation of rust to influence operation and durability harmfully made of the stainless steel (SUS304), and to maintain it easily in addition, a long life has been achieved.
- ◆ All the repair parts are prepared, it is possible to use it forever.
- ◆ This kit is attachable to most of all kinds of throttle-corn separate type grips for Harley Davidson regardless of its materials.

## Wire for Internal Throttle



This throttle cable features an adjuster in the middle of cable. Cables in three lengths are available to fit various types of handlebars. Please select the best one for smooth control and sharp contour.

Part#	Outer Cable	Length	Sug.Retail
880275	Black Vinyl	1300mm	\$22.05
880276	Black Vinyl	1500mm	\$23.10
880277	Black Vinyl	1800mm	\$24.15
880265	Stainless Braided	1300mm	\$32.55
880266	Stainless Braided	1500mm	\$33.60
880267	Stainless Braided	1800mm	\$34.65

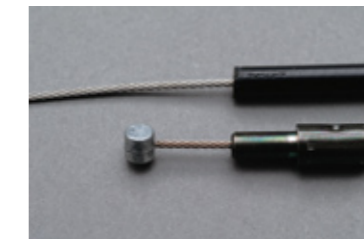

## Billet Grip for Internal Throttle

Grips are machined from billet aluminum. Knurling grips and Jack Hammer type grips in silver and black are available. This is must for riders who favor future-oriented custom building.

Part#	Type	Color	Sug.Retail
880300-SA	Knurling	Silver	\$155.40
880300-BA	Knurling	Black	\$155.40
880301-SA	Jack Hammer Type	Silver	\$207.90
880301-BA	Jack Hammer Type	Black	\$207.90



## φ 1 inch Internal Throttle Kit for LINKERT

Internal Throttle Kit is a throttle system to **push** wires through a pipe. This is the best item to make the appearance around the steering parts look sharp. Select the best one for you in consideration of the material and thickness of your handlebar.

### ■Characteristics

Duralumin 17S used for a slide barrel and WPC-MOS2 processing for the surface of the material reduce the slide friction. Also, the two made-in-Japan bearings in high quality in the slide barrel make very smooth control possible. The internal parts can be removed even while the kit is mounted, so wires can be easily removed or adjusted.

※WPC: A processing that can enhance the toughness and endurance of the material.

※MOS2: Molybdenum disulphide is inserted into the deeper part of a main material and re-crystallized. This processing enhances abrasion quality and reduces slide friction. Even when the main material is abraded away by friction, the layer of molybdenum disulphide spreads over the damaged spots and keeps its duration.

Part #	Handlebar Thickness	material	Sug.Retail
880360	1.6mm	Steel	\$299.25
880361	2.0mm	Steel	\$299.25
880365	1.5mm	Stainless Steel	\$325.50
880366	2.0mm	Stainless Steel	\$325.50

※ Regardless of a material of grips, this kit fits any grip for Harley-Davidson separated from a throttle corn.



## φ 7/8 inch Internal Throttle Kit

### ■Characteristics

Duralumin 17S used for a slide barrel and WPC-MOS2 processing for the surface of the material reduce the slide friction. Also, the two made-in-Japan bearings in high quality in the slide barrel make very smooth control possible. The internal parts can be removed even while the kit is mounted, so wires can be easily removed or adjusted.

※WPC: A processing that can enhance the toughness and endurance of the material.

※MOS2: Molybdenum disulphide is inserted into the deeper part of a main material and re-crystallized. This processing enhances abrasion quality and reduces slide friction. Even when the main material is abraded away by friction, the layer of molybdenum disulphide spreads over the damaged spots and keeps its duration.

Part #	Handlebar Thickness	material	Sug.Retail
642370	1.6mm	Steel	\$299.25
642371	2.0mm	Steel	\$299.25
642375	1.5mm	Stainless Steel	\$299.95
642376	2.0mm	Stainless Steel	\$299.95

※ Regardless of a material of grips, this kit fits any grip for Harley-Davidson separated from a throttle corn.



## Wire for Internal Throttle Kit to use LINKERT



Part#	Outer Cable	Length	Sug.Retail
880286	Black Vinyl	1500mm	\$29.40

MADE IN JAPAN

## Wire's for Internal Throttle Kit



Type1 Mainly for YAMAHA



Type2 Mainly for YAMAHA



Type3 Mainly for YAMAHA



Type4 Mainly for KAWASAKI



MADE IN JAPAN



Adjuster

The installationthe following play adjustment and maintenance are done easily and it is very convenient because it is addition of the adjuster for the adjustment of the inner wire. Moreover, you can choose from 4 kinds of metal fittingsin the carburetor installation part are preparatory by the installed model (carburetor), and confirm the carburetor installation part of the wire used now. It is strong, and strong in rust in making the inner wire made of the stainless steel. Black vinyl court finish and 1500mm in lengthof wire is available.

Part#	Type	Length	Sug.Retail
840276	Type1	1500mm	\$22.05
841276	Type2	1500mm	\$22.05
842276	Type3	1500mm	\$22.05
651276	Type4	1500mm	\$22.05

## "POSH Internal throttle kit"

Smooth operation and made of maintenance excellent, to decrease the sliding resistance as it is thoroughly as the WPC+MOS processing is given to the slide parts by using three highly accurate ball bearings for the rotation axis this time, a special design is done as well as a past kit. Moreover, it is a stainless steel almost in complete parts Generation is suppressed and the length life of rust also that is the cause of operation and durability in (SUS304) has been achieved.Please choose the inner sleeve that is welded and installed in thehandle bar according to the material and the thickness of the pipe.

(\* The processing to the inner sleeve might become necessary by the allowance of the pipe material of the handle bar.)

# Welding On Parts

## Bent Pipe 1.0-inch/90°

Bent pipes the same in size as handlebars. Please make your own handlebar by putting other items such as Short Riser for Welding On together.



Part #	material	Measurement	U/M	Sug.Retail
880150-50	Steel	A:270mm/B:240mm/C:50R	PR	\$50.40
880151-50	Stainless Steel	A:270mm/B:240mm/C:50R	PR	\$60.90
880150-65	Steel	A:285mm/B:285mm/C:65R	PR	\$50.40
880151-65	Stainless Steel	A:285mm/B:285mm/C:65R	PR	\$60.90
880150-80	Steel	A:300mm/B:190mm/C:80R	PR	\$50.40
880151-80	Stainless Steel	A:300mm/B:190mm/C:80R	PR	\$60.90

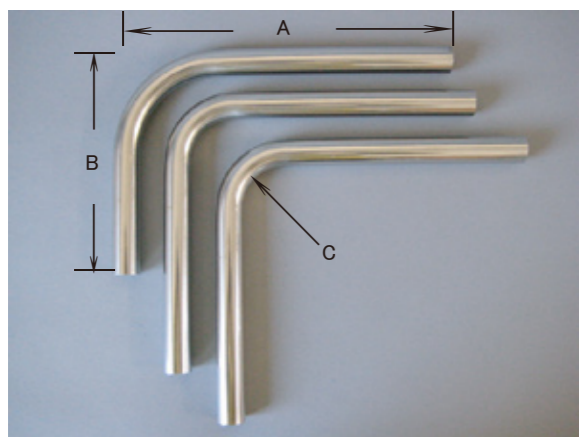

## Joint Riser for Welding On

These joint risers used for attaching handles directly to the top bridge are irreplaceable in customization today. The lineup features both steel and stainless steel types. Cut the handlebars to the desired length, insert the 20mm part into the pipe, and weld to use.



Part #	material	U/M	Sug.Retail
880160	Steel	PR	\$50.40
880161	Stainless Steel	PR	\$71.40

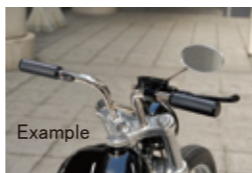

## Short Riser for Welding On

The lowest riser in our existing products created for customers who want curtail the height as much as possible. The height needed for mounting is 19mm. Please weld it on the handlebar.

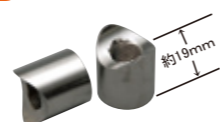

Part #	material	U/M	Sug.Retail
880165	Steel	PR	\$50.40
880166	Stainless Steel	PR	\$71.40



## Stay Collar for Welding On



These weld-on stay collars are just right for situations such as sissy bar and stay manufacturing. Their diameter lets them accommodate cap bolts. They can handle 3/8-inch and 5/16-inch bolts. And the lineup features both steel and stainless steel types. Great for a variety of processing uses such as one-off part manufacturing.

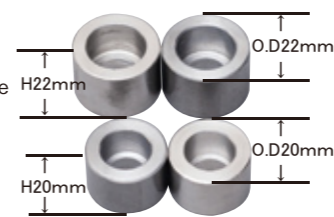

Part # (Size3/8)	Part # (Size5/16)	material	U/M	Sug.Retail
880100	880102	Steel	2pcs	\$10.50
880100-10	880102-10	Steel	10pcs	\$42.00
880101	880103	Stainless Steel	2pcs	\$16.80
880101-10	880103-10	Stainless Steel	10pcs	\$71.40

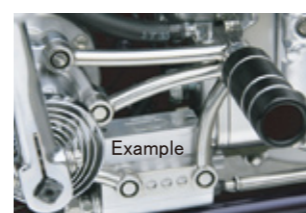

## Mount Tab Steel for Welding On

These weld-on mount tables are helpful for situations such as attaching a sissy bar to the frame or changing the rear step position. With 6mm tab thickness and 8mm hose diameter, they are resistant to warping when welding, strong, and adaptable to various situations such as modifying the hole diameter. Made of steel.



Part #	material	U/M	Sug.Retail
880104	Steel	2pcs	\$16.80
880104-10	Steel	10pcs	\$71.40



## Base for Jockey Shift Bracket

The original base plate convenient for mounting a jockey shift to a ratchet top mission. It is made of stainless steel and is 5mm wide so it is resistant to distortion by welding and suitable for various kinds of modification.



Part #	material	U/M	Sug.Retail
880130	Steel	Each	\$25.20
880131	Stainless Steel	Each	\$29.40
880130-5	Steel	5pcs	\$94.50
880131-5	Stainless Steel	5pcs	\$110.00



## Petcock Socket for Welding On

Sockets for  $\phi 22$ mm fuel cocks. Very useful for creating and modifying a tank. You can change the position of a fuel cock with this, then flexibility for custom-building increases. Please make a hole on the tank and weld it on.

Part #	material	U/M	Sug.Retail
880535	Steel	Each	\$39.90
880535-5	Steel	5pcs	\$159.60

※ We do not sell fuel cocks.  
 ● Whole length 57mm (including 7mm for screws)  
 ● Outer diameter 25mm X Inner diameter 20mm

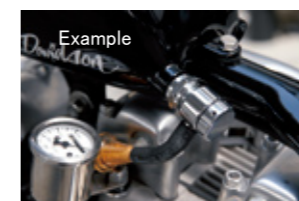

## Oil Line Fitting & Mounting Collar for Oil Tank

Fittings for oil line to create your own oil tank. Please weld it in consideration of the shape of the tank and the position of hoses.

Part #	material	U/M	Sug.Retail
880520	Steel	Each	\$9.45
880521	Stainless Steel	Each	\$12.60
880520-8	Steel	8pcs	\$56.7
880521-8	Stainless Steel	8pcs	\$75.6

● Length 10mm ● Outer Diameter 20mm ● Screw Pitch 1/8-27



As well as Oil Line Fitting, this mounting collar for a tank should be used when making your own oil tank. Please weld it on in consideration of the welding position of the tank.

Part #	material	U/M	Sug.Retail
880510	Steel	Each	\$12.60
880511	Stainless Steel	Each	\$16.80
880510-6	Steel	6pcs	\$56.7
880511-6	Stainless Steel	6pcs	\$75.6

● Length 20mm ● Outer Diameter 25mm ● Screw Pitch 5/16-18



● Example 1inch Bent Pipe 65R +Joint Riser



● Example 1inch Bent Pipe 50R +Joint Riser



# TT Handle & Plug Wiwe

## TT-type Handlebar

This is a reproduction of so-called "Flanders" type handlebars loved by '50s riders. It features the beauty of largely curved shape. The riders used to position it much lower than other types of handlebars for their fashion. We produce handlebars in house to control the production strictly. Also, we separate handlebars into two main parts, a pipe and grips, and braze them. In this way, we enhance the beauty and quality of handlebars.

Part #	Type	U/M	Width	Rise	Pullback	Sug.Retail
882150	#1 Standard	Each	835	105	187	\$441.00
882155	#1 Short	Each	805	105	152	\$441.00
882156	#2 Short	Each	750	90	140	\$441.00

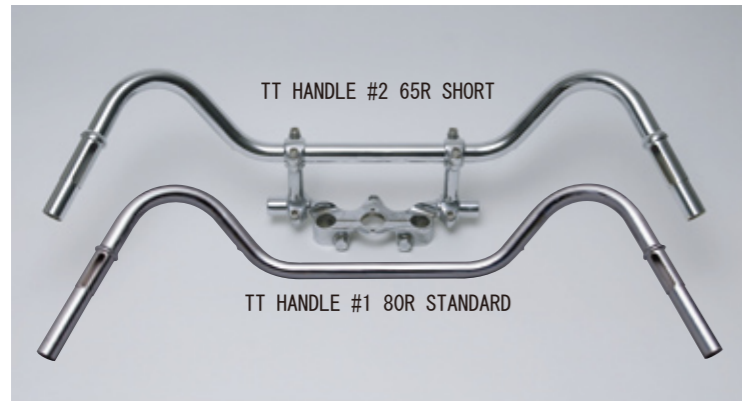

**[Part numbers corresponding to throttle parts]**

Handlebar end nut	56287-36
Handlebar spiral	56245-35
Plunger	3316-31
Throttle Pin	9281
Roller block	56281-31
Collar	56278-10

A throttle part fits 1936-48 "Big Twin" genuine parts. For a shorter type, a handlebar spiral has to be shortened.



**MADE IN JAPAN**



● Example installation



● Example installation

## Throttle Wire

Part #	Outer	U/M	Sug.Retail
882276	Black Vinyl	Each	\$29.40

OEM 56502-32



**MADE IN JAPAN**

## Cotton Braided Ignition Wire

It is the cotton braided plug wire of a classical taste. It combines IG connector and a plug cap sold separately, and uses it. The IG connector recommends the purchase after confirmed the existing motorcycle.

Part #	Length	U/M	Sug.Retail
880600	1m	Each	\$10.50
880600-10	10m	Each	\$52.50



● Example installation

## Spark-plug Conversion ADAPTER

A thermal value for a BPR-HS plug is 8, but BR-ES plug gets usable by using this adaptor. Duralumin machined-body and the width is 6.5mm. You just attach it to a joint to a BR-ES plug.

Part #	U/M	Sug.Retail
490010	Each	\$5.25

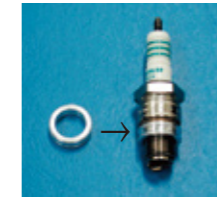

## Terminal Nut

To use Taylor silicon cord, a terminal nut has to be put on a plug head. If your plug does not have a terminal nut, this terminal nut is necessary.

Part #	U/M	Sug.Retail
800024	Each	\$3.15



## Ignition Wire Connector for Harley Davidson

To attach a Taylor silicon cord to an ignition coil of Harley-Davidson, this connector is necessary.

Corresponding Motorcycle	Part #	U/M	Sug.Retail
Twincam 88	883025	PR	\$5.25
SportSter('04-)	883025	PR	\$5.25
BigTwin (-'99)	880025	PR	\$5.25
SportSter(-'03)	880025	PR	\$5.25

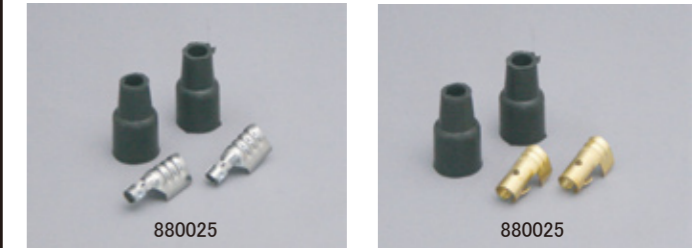

880025

880025

## Classical plug Cap



Part #	U/M	Sug.Retail
880010	PR	\$8.40





# MINI-SWITCH for 1-inch. Handlebar

Assemblies of a tiny switch for turn signal and horn. Along with an internal throttle kit, it makes the appearance around steering device look sharp. Four types of housing, two types of toggles, manual / automatic switches (using spring return) for turn signal lights are available.

■Characteristic: The housing is very tiny in 41mm by 18mm.

Black Coated Lever (Toggle Switch)



Flat Bar Lever (Toggle Switch)



The most basic type machined from billet aluminum.



Bottom of this product. It may be required to put a part of the switch unit into the inside of a handle pipe.



Matches classical-looking custom building.



Two different looks for both manual and automatic type.

Part #	Toggle	Cancel	Housing	Sug.Retail
880210	Black Coated	Manual	Chrone Plating	\$50.40
880211	Black Coated	Manual	Aluminum Cut Out	\$50.40
880212	Black Coated	Manual	Brass Cut out	\$50.40
880213	Black Coated	Manual	Black Anodized	\$50.40
880214	Black Coated	Manual	Black Winkle Paint	\$50.40
880220	Black Coated	Auto	Chrone Plating	\$50.40
880221	Black Coated	Auto	Aluminum Cut Out	\$50.40
880222	Black Coated	Auto	Brass Cut out	\$50.40
880223	Black Coated	Auto	Black Anodized	\$50.40
880224	Black Coated	Auto	Black Winkle Paint	\$50.40
880230	Flat Bar	Manual	Chrone Plating	\$50.40
880231	Flat Bar	Manual	Aluminum Cut Out	\$50.40
880232	Flat Bar	Manual	Brass Cut out	\$50.40
880233	Flat Bar	Manual	Black Anodized	\$50.40
880234	Flat Bar	Manual	Black Winkle Paint	\$50.40
880240	Flat Bar	Auto	Chrone Plating	\$50.40
880241	Flat Bar	Auto	Aluminum Cut Out	\$50.40
880242	Flat Bar	Auto	Brass Cut out	\$50.40
880243	Flat Bar	Auto	Black Anodized	\$50.40
880244	Flat Bar	Auto	Black Winkle Paint	\$50.40



※ Automatic-cancel is not electrical function, but it works by releasing fingers from the toggle.  
 ※ Only one type for homing button (push button) is available.



# 1 Hole MINI SWITCH for 1-inch. Handlebar

The switch bracket considers the size with other combination parts such as the Brake & clutch levers. It is designed to become small as much as possible, and the custom around a simple handle bar. One hall type of the mini switch with a lot of demands.

For Turn Signal or horn for 1 inch handle bar.

It produces it with beginning cut everything down, and the switch bracket is finish and a switch of the switch bracket.

■Characteristic: The housing is very tiny in 28mm by 19mm. No switch smaller than this is available

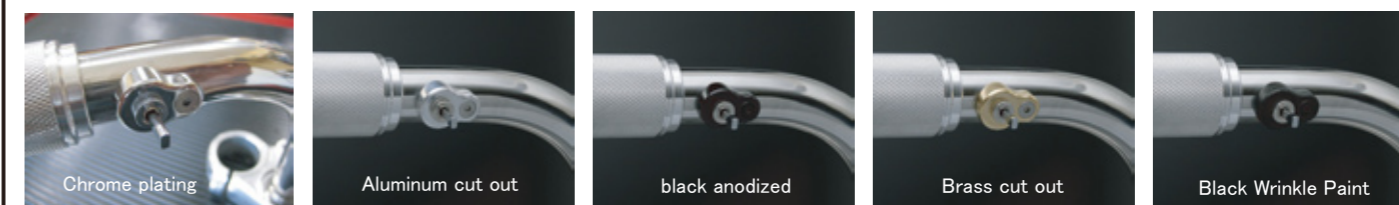

## Drilling JIG BLOCK for 1-inch MINI-SWITCH

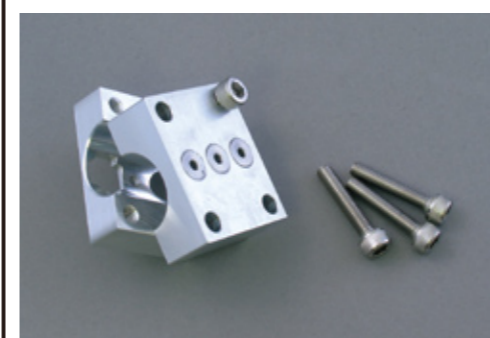

Drill jig for mini-switch. It drills a pilot hole 3mm diameter for M4 fixing screws of a switch housing. The half side of this block can put marking-off for a toggle switch and a push button switch. The width of this block is 41mm and the same as the width of the switch housing. So, you can drill holes while checking the mounting location.



Part #	Size	Sug.Retail
880206	50 x 41mm	\$ 78.75

Part #	Toggle	Cancel	Housing	Sug.Retail
880330	Flat Bar	Manual	Chrone Plating	\$39.90
880331	Flat Bar	Manual	Aluminum Cut Out	\$39.90
880332	Flat Bar	Manual	Brass Cut out	\$39.90
880333	Flat Bar	Manual	Black Anodized	\$39.90
880334	Flat Bar	Manual	Black Winkle Paint	\$39.90
880340	Flat Bar	Auto	Chrone Plating	\$39.90
880341	Flat Bar	Auto	Aluminum Cut Out	\$39.90
880342	Flat Bar	Auto	Brass Cut out	\$39.90
880343	Flat Bar	Auto	Black Anodized	\$39.90
880344	Flat Bar	Auto	Black Winkle Paint	\$39.90

Part #	Switch	Housing	Sug.Retail
880350	Push	Chrone Plating	\$39.90
880351	Push	Aluminum Cut Out	\$39.90
880352	Push	Brass Cut out	\$39.90
880353	Push	Black Anodized	\$39.90
880354	Push	Black Winkle Paint	\$39.90

※ Automatic-cancel is not electrical function, but it works by releasing fingers from the toggle.  
 ※ Only one type for homing button (push button) is available.



# MINI-SWITCH for 7/8-inch Handlebar

Assemblies of a tiny switch for turn signal and horn. Along with an internal throttle kit, it makes the appearance around steering device look sharp. Four types of housing, two types of toggles, manual / automatic switches (using spring return) for turn signal lights are available.

■Characteristic: The housing is very tiny in 41mm by 18mm.

Black Coated Lever (Toggle Switch)

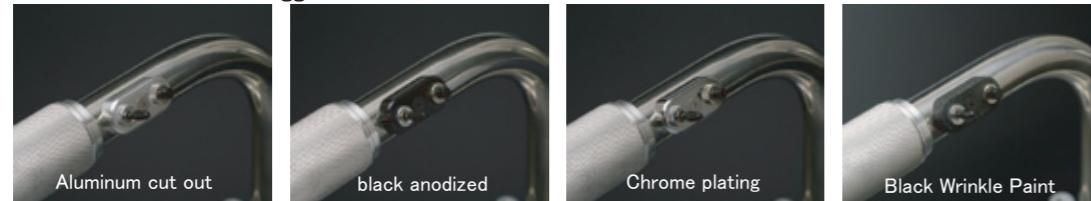

Flat Bar Lever (Toggle Switch)



The most basic type machined from billet aluminum.



Bottom of this product. It may be required to put a part of the switch unit into the inside of a handle pipe.

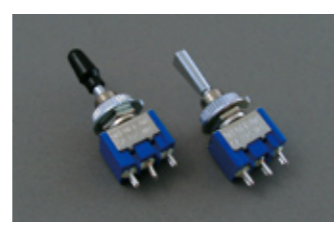

Toggle Switches

Part #	Toggle	Cancel	Housing	Sug.Retail
642210	Black Coated	Manual	Chrome Plating	\$50.40
642211	Black Coated	Manual	Aluminum Cut Out	\$50.40
642213	Black Coated	Manual	Black Anodized	\$50.40
642214	Black Coated	Manual	Black Wrinkle Paint	\$50.40
642230	Flat Bar	Manual	Chrome Plating	\$50.40
642231	Flat Bar	Manual	Aluminum Cut Out	\$50.40
642233	Flat Bar	Manual	Black Anodized	\$50.40
642234	Flat Bar	Manual	Black Wrinkle Paint	\$50.40

MADE IN JAPAN



●Example installation XS650

# 1 Hole MINI SWITCH for 7/8-inch Handlebar

The switch bracket considers the size with other combination parts such as the Brake & clutch levers. It is designed to become small as much as possible, and the custom around a simple handle bar. One hall type of the mini switch with a lot of demands.

For Turn Signal or horn for 1 inch handle bar.

It produces it with beginning cut everything down, and the switch bracket is finish and a switch of the switch bracket.

■Characteristic: The housing is very tiny in 28mm by 19mm. No switch smaller than this is available

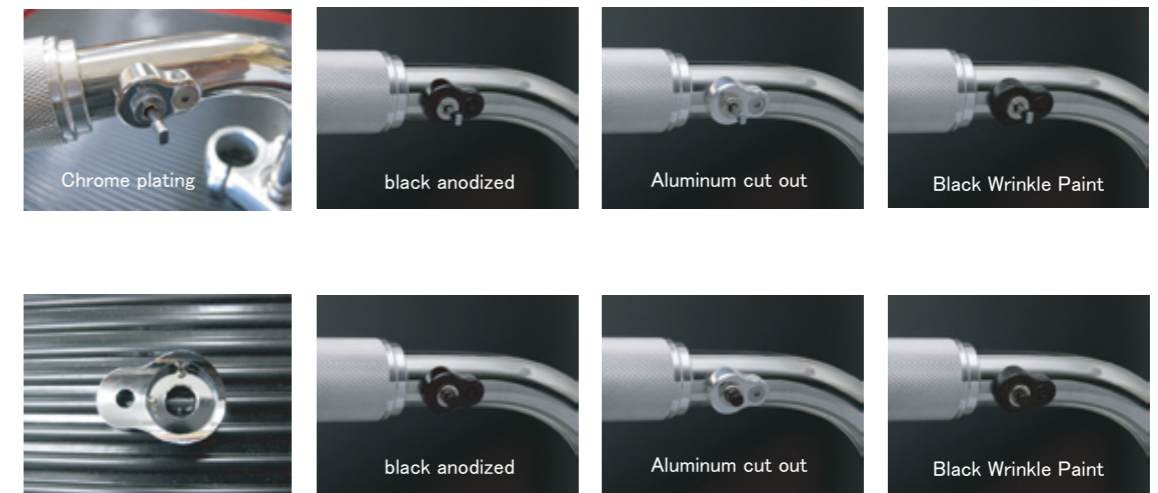

## Drilling JIG BLOCK for 7/8-inch MINI-SWITCH

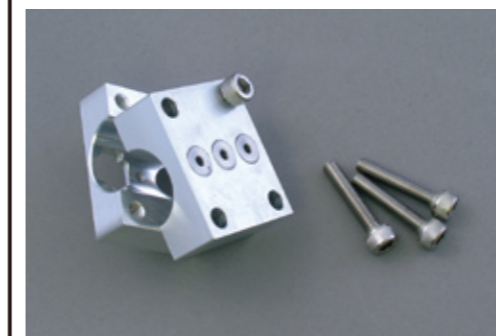

Drill jig for mini-switch. It drills a pilot hole 3mm diameter for M4 fixing screws of a switch housing. The half side of this block can put marking-off for a toggle switch and a push button switch. The width of this block is 41mm and the same as the width of the switch housing. So, you can drill holes while checking the mounting location.

MADE IN JAPAN

Part #	Size	Sug.Retail
642205	50 x 41mm	\$ 78.75

Part #	Toggle	Cancel	Housing	Sug.Retail
642330	Flat Bar	Manual	Chrome Plating	\$39.90
642331	Flat Bar	Manual	Aluminum Cut Out	\$39.90
642333	Flat Bar	Manual	Black Anodized	\$39.90
642334	Flat Bar	Manual	Black Wrinkle Paint	\$39.90
642340	Flat Bar	Auto	Chrome Plating	\$39.90
642341	Flat Bar	Auto	Aluminum Cut Out	\$39.90
642343	Flat Bar	Auto	Black Anodized	\$39.90
642344	Flat Bar	Auto	Black Wrinkle Paint	\$39.90

Part #	Switch	Housing	Sug.Retail
642350	Push	Chrome Plating	\$39.90
642351	Push	Aluminum Cut Out	\$39.90
642353	Push	Black Anodized	\$39.90
642354	Push	Black Wrinkle Paint	\$39.90

※ Automatic-cancel is not electrical function, but it works by releasing fingers from the toggle.  
 ※ Only one type for horning button (push button) is available.

MADE IN JAPAN

## Adjustable Plate for Transmission Case

A supporting plate for the transmission case corresponding to 4-speed transmission bike frames. Aluminum 7075 known as a material for aircrafts is used for this product. Each component created with highly accurate measurement makes precise adjustment possible. Highly recommended for the belt drive system.

※Some adjustments to the transmission case as well as hole-drilling are needed when attaching it to frames from '36 to '57 model.

※Only the transmission case has to be adjusted for the frames from '58 to '69 model.

Part #	material	U/M	Sug.Retail
882100	7075	Each	\$270.90



MADE IN JAPAN



## Speed Meter Cable for 4speed Transmission

It becomes short speed meter cable for the four-speed mission. Just good length 17.5inch(445mm) for meter transfer when chopper is produced. Please choose from black vinyl/stainless steel braided type.

Part #	Outer Cable	U/M	Sug.Retail
880175	Black Vinyl	Each	\$21.00
880176	Stainless Braided	Each	\$39.90



Size 7/8-18 of body side installation screw.  
Size of meter side installation screw M12.

To Speed Meter



## Adjustable Kickstand Stop

Adjustable kickstandstop protects the primary case from the kickstand. Screw with nut provides adjustment for proper kickstand position.

Part #	material	U/M	Sug.Retail
880800	Stainless Steel	Kit	\$33.60



●Example installation



Made from Stainless steel

MADE IN JAPAN

## Axle Paint Saver Kit

The chain adjustment and the detaching work of a rear axle shaft become possible without hurting the painting of the frame by putting up this plate. Full dress is effective and rust at the same time because both plates and bolts are made of stainless steels.

Stainless bolt made by DIAMOND ENGINEERING use.

Part #	material	U/M	Sug.Retail
880818	Stainless Steel	Kit	\$37.80

MADE IN JAPAN

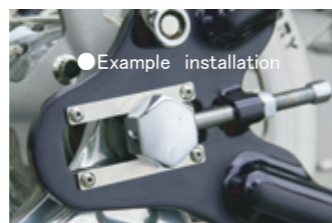

●Example installation



It installs it in shape that drilled hole/processes the tap to the frame, places between a rear axle shaft and the frame axle installation part. 9mm width bolt in made of stainless steel/71mm length/62mm bolt pitch.

## LED Low Profile Taillight

LED taillight unit for normal taillight mounting. The width of lenses including the bases is curtailed in 1/3 so that the design stays normal and still stylish.

It fits models from 1999 to TWIN CAM comprehensively. You just remove a genuine taillight from the base plate and replace the connector.

※It does not fit Fat Bob fender.

Part #	Color	U/M	Sug.Retail
880250	Red	Kit	\$134.40
880251	Clear	Kit	\$134.40
880252	Smoke	Kit	\$134.40



## Early Barrel Grip

It is a grip produced sticking to over the detail such as total length designed to suit shape of saliva that considered the match with the mini switch and a simple handle bar, lame conditions, and color though it is a design that is reminiscent of the AMAL type of 60's.

\* Choosing from according to each of four colors and two size for handle bar diameter  $\phi$  1inch( $\phi$  25.4mm) and 7/8inch( $\phi$  22.2mm).



for 1 inch Handlebar

Part #	Color	Handle bar O.D	Length (Depth)	U/M	Sug.Retail
811450	Black	$\phi$ 1inch	118mm (115mm.)	PR	\$25.20
811451	White	$\phi$ 1inch	118mm (115mm)	PR	\$25.20
811452	Red Flake	$\phi$ 1inch	118mm (115mm)	PR	\$27.30
811453	Silver Flake	$\phi$ 1inch	115mm 115mm	PR	\$27.30

for 7/8 inch Handlebar

Part #	Color	Handle bar O.D	Length (Depth)	U/M	Sug.Retail
811440	Black	$\phi$ 7/8inch	118mm (115mm)	PR	\$18.90
811441	White	$\phi$ 7/8inch	118mm (115mm)	PR	\$18.90
811442	Red Flake	$\phi$ 7/8inch	118mm (115mm)	PR	\$21.00
811443	Silver Flake	$\phi$ 7/8inch	118mm (115mm)	PR	\$21.00

MADE IN JAPAN

## Sport Ride GRIP with Inner Pipe

Accompanied with throttle pipes for Harley Davidson / dual cables.



Part #	Color	U/M	Sug.Retail
883300	Black	PR	\$39.90
883301	Red	PR	\$39.90
883302	Blue	PR	\$39.90
883305	White	PR	\$39.90
883306	Orange	PR	\$39.90

## Sport Ride Grip for 1-Inch Bar

Grips for sport riding and made of "elastomer", which is worldly recognized as a material for grips. Length is 115mm and grips are penetrated to the end.



Part #	Color	U/M	Sug.Retail
811390	Black	PR	\$29.40
811391	Red	PR	\$29.40
811392	Blue	PR	\$29.40
811395	White	PR	\$29.40
811396	Orange	PR	\$29.40

## Foam Rubber GRIP for 1-Inch Handlebar

This soft grip made of sponge is attached to a 1 inch handlebar ( $\phi$ 22.2mm) for Harley Davidson.



Part #	Type	Length	U/M	Sug.Retail
811422	STD	132mm(Depth:123mm)	PR	\$23.10
811423	LONG	150mm(Depth:141mm)	PR	\$25.20

## End Nut for 1-Inch Handlebar

The body part is machined from billet aluminum and fits a pipe in 21.4 mm diameter. It should be used with grips for sport riding.



Part #	Color	U/M	Sug.Retail
883310	Blue	PR	\$23.10
883311	Silver	PR	Sold Out
883312	Black	PR	Sold Out
883313	Chrome	PR	\$29.40

# Bent Pipes for Exhaust Pipes

Bent pipes are a very useful material for creating your own muffler. Stainless steel pipes and steel pipes are available, and each has 3 different levels of inner diameters and 19 levels of angle. High circularity free of unnatural distortion and steps are achieved. You will be satisfied with the quality of our bent pipes as a material for your custom building.

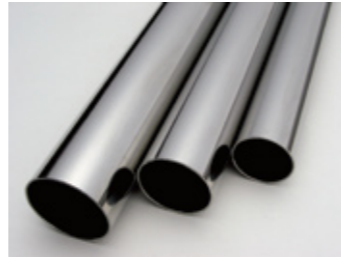

Stainless steel pipes



Steel pipes



● Example "Pan Shovel"



● Example "Knuckle"



● Example "XS650"



● Example "Sport Ster"

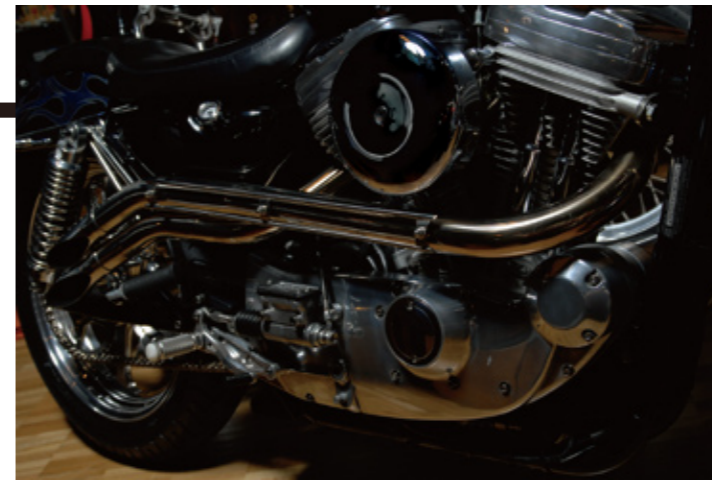

◀ Example of use of bent pipes.  
Type : SPORTSTER  
The bent pipes used in this example  
Front:φ45×160°/20°/40°/60°  
Rear:φ45×60°/40°/60°



▶ Example of use of bent pipes  
Type: DYNA  
The bent pipes used in this example  
Front:φ50.8×30°/80°/30°/30°  
Rear:φ45×80°/140°



Bent pipes being welded on an exhaust pipe



Three dimensional pipe bender enables us to create bent pipes in much higher quality. We consider careful management of the production line as a crucial factor, so all bent pipes are manufactured in our own factory.



MADE IN JAPAN

## Order system for bent pipes

You can specify the length and angles.  
You need to ask a separate quote, so please feel free to inquire.  
★Three sizes of inner diameter in 38.1, 45, and 50.8 are available.  
You can not specify the radius of pipes.  
★Please refer to p.21 about inquiries.

## List of Bent Pipes

This page items are  MADE IN JAPAN

Lengths are approx.15mm longer on straight part. Pipe Thick Steel=1.6mm / Stainless Steel =1.5mm

### φ38.1 (Radius 100mm) Steel

Part #	Thickness	Angle	Length	Material	Sug.Retail
881052-01	1.6	10°	174	Steel	\$18.90
881052-02	1.6	20°	191	Steel	\$18.90
881052-03	1.6	30°	208	Steel	\$19.42
881052-04	1.6	40°	225	Steel	\$19.95
881052-05	1.6	50°	243	Steel	\$20.47
881052-06	1.6	60°	260	Steel	\$20.47
881052-07	1.6	70°	278	Steel	\$21.00
881052-08	1.6	80°	296	Steel	\$21.00
881052-09	1.6	90°	313	Steel	\$21.52
881052-10	1.6	100°	330	Steel	\$22.05
881052-11	1.6	110°	348	Steel	\$22.57
881052-12	1.6	120°	365	Steel	\$23.10
881052-13	1.6	130°	382	Steel	\$23.10
881052-14	1.6	140°	400	Steel	\$23.62
881052-15	1.6	150°	418	Steel	\$23.62
881052-16	1.6	160°	435	Steel	\$24.15
881052-17	1.6	170°	452	Steel	\$24.15
881052-18	1.6	180°	470	Steel	\$25.20
881052-00	1.6	Straight	995	Steel	\$26.25

### φ38 (Radius 100mm) Stainless Steel

Part #	Thickness	Angle	Length	Material	Sug.Retail
881057-01	1.5	10°	174	Stainless Steel	\$25.72
881057-02	1.5	20°	191	Stainless Steel	\$26.77
881057-03	1.5	30°	208	Stainless Steel	\$27.82
881057-04	1.5	40°	225	Stainless Steel	\$28.35
881057-05	1.5	50°	243	Stainless Steel	\$28.87
881057-06	1.5	60°	260	Stainless Steel	\$29.92
881057-07	1.5	70°	278	Stainless Steel	\$30.45
881057-08	1.5	80°	296	Stainless Steel	\$31.50
881057-09	1.5	90°	313	Stainless Steel	\$32.55
881057-10	1.5	100°	330	Stainless Steel	\$34.12
881057-11	1.5	110°	348	Stainless Steel	\$34.65
881057-12	1.5	120°	365	Stainless Steel	\$35.70
881057-13	1.5	130°	382	Stainless Steel	\$36.75
881057-14	1.5	140°	400	Stainless Steel	\$37.27
881057-15	1.5	150°	418	Stainless Steel	\$37.80
881057-16	1.5	160°	435	Stainless Steel	\$38.85
881057-17	1.5	170°	452	Stainless Steel	\$39.90
881057-18	1.5	180°	470	Stainless Steel	\$40.42
881057-00	1.5	Straight	995	Stainless Steel	\$40.95

### φ45.0 (Radius 120mm) Steel

Part #	Thickness	Angle	Length	Material	Sug.Retail
881050-01	1.6	10°	186	Steel	\$17.32
881050-02	1.6	20°	207	Steel	\$17.85
881050-03	1.6	30°	228	Steel	\$18.37
881050-04	1.6	40°	249	Steel	\$18.37
881050-05	1.6	50°	270	Steel	\$18.90
881050-06	1.6	60°	295	Steel	\$19.95
881050-07	1.6	70°	312	Steel	\$19.95
881050-08	1.6	80°	333	Steel	\$20.47
881050-09	1.6	90°	354	Steel	\$20.47
881050-10	1.6	100°	375	Steel	\$21.00
881050-11	1.6	110°	396	Steel	\$21.52
881050-12	1.6	120°	417	Steel	\$21.52
881050-13	1.6	130°	438	Steel	\$22.05
881050-14	1.6	140°	459	Steel	\$22.57
881050-15	1.6	150°	480	Steel	\$23.10
881050-16	1.6	160°	501	Steel	\$23.62
881050-17	1.6	170°	522	Steel	\$24.15
881050-18	1.6	180°	543	Steel	\$24.67
881050-00	1.6	Straight	995	Steel	\$24.15

### φ45.0 (Radius 120mm) Stainless Steel

Part #	Thickness	Angle	Length	Material	Sug.Retail
881055-01	1.5	10°	186	Stainless Steel	\$24.15
881055-02	1.5	20°	207	Stainless Steel	\$25.20
881055-03	1.5	30°	228	Stainless Steel	\$26.25
881055-04	1.5	40°	249	Stainless Steel	\$27.30
881055-05	1.5	50°	270	Stainless Steel	\$28.35
881055-06	1.5	60°	295	Stainless Steel	\$29.40
881055-07	1.5	70°	312	Stainless Steel	\$30.97
881055-08	1.5	80°	333	Stainless Steel	\$32.55
881055-09	1.5	90°	354	Stainless Steel	\$33.60
881055-10	1.5	100°	375	Stainless Steel	\$34.65
881055-11	1.5	110°	396	Stainless Steel	\$35.17
881055-12	1.5	120°	417	Stainless Steel	\$36.75
881055-13	1.5	130°	438	Stainless Steel	\$37.80
881055-14	1.5	140°	459	Stainless Steel	\$38.85
881055-15	1.5	150°	480	Stainless Steel	\$39.90
881055-16	1.5	160°	501	Stainless Steel	\$42.52
881055-17	1.5	170°	522	Stainless Steel	\$43.05
881055-18	1.5	180°	543	Stainless Steel	\$43.57
881055-00	1.5	Straight	995	Stainless Steel	\$42.00

### φ50.8 (Radius 100mm) Steel

Part #	Thickness	Angle	Length	Material	Sug.Retail
881051-01	1.6	10°	194	Steel	\$17.85
881051-02	1.6	20°	211	Steel	\$18.37
881051-03	1.6	30°	228	Steel	\$18.90
881051-04	1.6	40°	245	Steel	\$18.90
881051-05	1.6	50°	263	Steel	\$19.42
881051-06	1.6	60°	280	Steel	\$19.42
881051-07	1.6	70°	298	Steel	\$19.95
881051-08	1.6	80°	316	Steel	\$20.47
881051-09	1.6	90°	333	Steel	\$20.47
881051-10	1.6	100°	350	Steel	\$21.00
881051-11	1.6	110°	368	Steel	\$21.52
881051-12	1.6	120°	385	Steel	\$22.05
881051-13	1.6	130°	402	Steel	\$22.57
881051-14	1.6	140°	420	Steel	\$22.57
881051-15	1.6	150°	438	Steel	\$23.10
881051-16	1.6	160°	455	Steel	\$23.62
881051-17	1.6	170°	472	Steel	\$24.15
881051-18	1.6	180°	490	Steel	\$24.67
881051-00	1.6	Straight	995	Steel	\$26.25

### φ50.8 (Radius 100mm) Stainless Steel

Part #	Thickness	Angle	Length	Material	Sug.Retail
881056-01	1.5	10°	228	Stainless Steel	\$24.67
881056-02	1.5	20°	245	Stainless Steel	\$25.72
881056-03	1.5	30°	263	Stainless Steel	\$26.77
881056-04	1.5	40°	280	Stainless Steel	\$27.30
881056-05	1.5	50°	298	Stainless Steel	\$27.82
881056-06	1.5	60°	316	Stainless Steel	\$28.87
881056-07	1.5	70°	333	Stainless Steel	\$29.92
881056-08	1.5	80°	350	Stainless Steel	\$31.50
881056-09	1.5	90°	368	Stainless Steel	\$33.07
881056-10	1.5	100°	385	Stainless Steel	\$34.12
881056-11	1.5	110°	402	Stainless Steel	\$35.17
881056-12	1.5	120°	420	Stainless Steel	\$36.22
881056-13	1.5	130°	438	Stainless Steel	\$37.27
881056-14	1.5	140°	455	Stainless Steel	\$38.32
881056-15	1.5	150°	472	Stainless Steel	\$38.85
881056-16	1.5	160°	490	Stainless Steel	\$40.42
881056-17	1.5	170°	508	Stainless Steel	\$41.47
881056-18	1.5	180°	526	Stainless Steel	\$43.05
881056-00	1.5	Straight	995	Stainless Steel	\$43.57

### φ45.0 (Radius 55mm) Steel

Part #	Angle	Sug.Retail	Part #	Angle	Sug.Retail
881040-030	30°	\$19.95	881040-090	90°	\$25.20
881040-045	45°	\$21.00	881040-120	120°	\$26.77
881040-060	60°	\$22.05	881040-150	150°	\$28.35
881040-075	75°	\$23.10	881040-180	180°	\$29.92

### φ50.8 (Radius 65mm) Steel

Part #	Angle	Sug.Retail	Part #	Angle	Sug.Retail
881041-030	30°	\$21.00	881041-090	90°	\$25.72
881041-045	45°	\$22.05	881041-120	120°	\$27.30
881041-060	60°	\$23.10	881041-150	150°	\$28.87
881041-075	75°	\$24.15	881041-180	180°	\$30.45

# Muffler Componentry

## Joint Pipe for "Pan Head"

In the case of the muffler production of the pan head, it is a joint pipe to use. When the band for fixation is tightened by putting the slit in the insertion part to the head by four places, it becomes familiar well, and an excessive tightening torque is not needed for the installation like the two-place slit. It is firmly installed by assuming the depth of the slit to be 15mm and using it together with our stainless exhaust band (product number 800663).  
\* Please choose from stainless steel/steel according to the material of the muffler.  
\* Might of shut when the installed head is thin.  
\* Please note the tightening torque when you install it.

Part #	material	U/M	Sug.Retail
880050	Steel	Each	\$16.80
880051	Stainless Steel	Each	\$22.05

 MADE IN JAPAN



Example installation



Steel Stainless Steel

## Muffler Bracket for Welding On

There is free position degree when stay is installed by making the stay installation part a slide type, and very convenient to make a muffler stay. The bracket is used in the muffler, and after it welds, and the stud bolt is adjusted to arbitrary length, it welds and it uses for the square nut as T bolt.  
\* Please choose from stainless steel/steel according to the material of the muffler.



Part #	material	U/M	Sug.Retail
880444	Steel	Kit	\$21.00
880445	Stainless Steel	Kit	\$21.00

 MADE IN JAPAN

## Joint Pipe

 MADE IN JAPAN

It is the spread pipe which is convenient when you convert pipe size into φ 45 to φ 50.8 and φ 38 to φ 45. The production of the image of the exhaust pipe of a twin cam with the pipe of φ 50.8 like the third picture, and the image can do various processings as use like the fourth picture etc. It is depending on the idea.  
Please choose from stainless steel/steel according to the material and the size of the muffler.

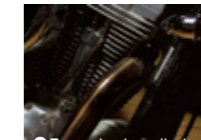
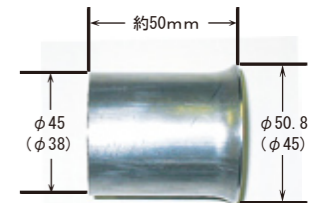

Part #	material	Size	U/M	Sug.Retail
850052	Steel	45→50.8mm	Each	\$12.60
850057	Stainless Steel	45→50.8mm	Each	\$15.75
850053	Steel	38→45mm	Each	\$12.60
850058	Stainless Steel	38→45mm	Each	\$15.75

## Flange for "Shovel Head"

It is a flange that the shovel uses when the muffler is produced. It processes by the laser, and it curves, and it is a thing without whether/collar and after the installation, the shake corner of about the right and left 5° Muffler can be adjusted by doing to the length hole of the installation bolt hole of the muffler.  
\* It supports pipe external form φ 45.  
\* Please choose from stainless steel/steel according to the material of the muffler.



 MADE IN JAPAN

Part #	material	U/M	Sug.Retail
880440	Steel	Each	\$16.80
880441	Stainless Steel	Each	\$22.05

## Stainless Steel Ring for EVO Muffler

It is exhaust pipe ring that EVO/TWIN CAM uses for the joint to the head when the muffler is produced.  
Please choose from stainless steel/steel according to the material of the muffler.

Part #	material	U/M	Sug.Retail
880442	Steel	Each	\$12.60
880443	Stainless Steel	Each	\$15.75

 MADE IN JAPAN



## Exhaust Gasket



for shovel head  
Part#880590

for earlier period of EVO  
Part#881590

for last part of EVO  
Part#882590

The gasket used when the muffler production and exchanging it was variously prepared by the model type. It is an original gasket that used the high-quality material suitable for each usage. Please use it by all means when you exchange it.

## Stainless Steel Muffler Clamp

# Rearview Mirror "Casting"

A luxurious product with a mirror housing made of aluminum cast. Mounting hardware such as brackets and nuts are all made of stainless steel. Various designs and different lengths of stems are available to match characteristics of your motorcycle and handlebar. It features the stateliness and beauty that perfectly match Harley-Davidson.



## 3-inch Round Shape

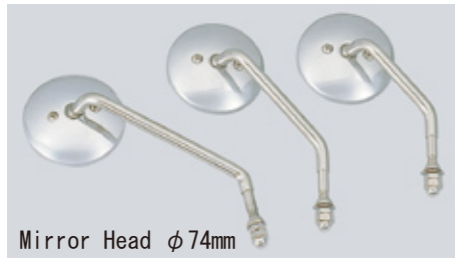

Mirror Head  $\phi$  74mm

Part #	Stem	Right/Left	U/M	Sug.Retail
880400	Short	Right	Each	\$47.25
880401	Short	Left	Each	\$47.25
880380	Standard	Right	Each	\$47.25
880381	Standard	Left	Each	\$47.25
880420	Long	Right	Each	\$52.50
880421	Long	Left	Each	\$52.50

## "Vintage" Oval Shape



Mirror Head W104mm x H66mm

Part #	Stem	Right/Left	U/M	Sug.Retail
880385	Standard	Right	Each	\$50.40
880386	Standard	Left	Each	\$50.40
880425	Long	Right	Each	\$52.50
880426	Long	Left	Each	\$52.50

## "MINI-Square"



Mirror Head W100mm x H46mm

Part #	Stem	Right/Left	U/M	Sug.Retail
880410	Short	Right	Each	\$47.25
880411	Short	Left	Each	\$47.25
880390	Standard	Right	Each	\$47.25
880391	Standard	Left	Each	\$47.25
880430	Long	Right	Each	\$52.50
880431	Long	Left	Each	\$52.50

## 3.5-inch Round Shape



Mirror Head  $\phi$  92mm

Part #	Stem	Right/Left	U/M	Sug.Retail
880382	Standard	Right	Each	\$50.40
880383	Standard	Left	Each	\$50.40
880422	Long	Right	Each	\$52.50
880423	Long	Left	Each	\$52.50

## "Vintage" Round Shape



Mirror Head W112mm x H63mm

Part #	Stem	Right/Left	U/M	Sug.Retail
880415	Short	Right	Each	\$50.40
880416	Short	Left	Each	\$50.40
880395	Standard	Right	Each	\$50.40
880396	Standard	Left	Each	\$50.40
880435	Long	Right	Each	\$52.50
880436	Long	Left	Each	\$52.50

## Square Shape Basic



Mirror Head W105mm x H68mm

Part #	Stem	Right/Left	Sug.Retail
880392	Standard	Right	\$50.40
880393	Standard	Left	\$50.40
880432	Long	Right	\$52.50
880433	Long	Left	\$52.50

This page items are MADE IN JAPAN

# Wide View Mirror Series

This page items are



## Wide View "Curving line"



Mirror Head W132mm x H86mm

Part #	Right/Left	U/M	Sug.Retail
880450	Right	Each	\$70.35
880451	Left	Each	\$70.35

## Wide View "Square"



Mirror Head W122mm x H85mm

Part #	Right/Left	U/M	Sug.Retail
880452	Both	Each	\$70.35

## Wide View "Slim Line"



Mirror Head W137mm x H80mm

Part #	Right/Left	U/M	Sug.Retail
880455	Both	Each	\$70.35



# Brass Head Series

## Brass Head "MINI-Square" SUS Stay



Mirror Head W100mm x H46mm

Part #	Right/Left	U/M	Sug.Retail
880530	Right	Each	\$81.90
880531	Left	Each	\$81.90

## Brass Head "MINI-Square" Black Stay



Mirror Head W100mm x H46mm

Part #	Right/Left	U/M	Sug.Retail
880540	Right	Each	\$81.90

# Turn Signal Light

14 types of turn signal lights for Harley-Davidson are available in our product lineup, and each type has various kinds of lens colors. Mounting hardware with brackets and wiring accessories for Sportster, Softail, and Dyna-Frame are also available. Please select the best one in consideration of concept and tastes for your custom building. (Sold in pairs for right and left)

## Brimmed Rim Model

- 1) 12V 23W bulbs are supplied with each unit. Amber bulbs are available for Clear, Smoke, Chromium-plated lens. (type "Mirror")
- 2) Bolts and washers are made of stainless steel.
- 3) In consideration of weep holes, the turn signal lights are designed differently for right and left side.
- 4) M10 and M8 bolts are available for mounting.
- 5) Please consult us regarding parts for repair.

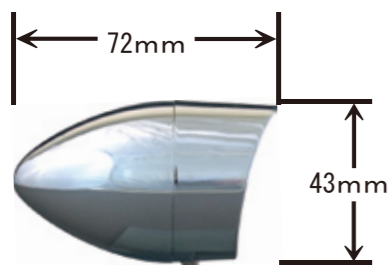

### Brimmed Rim



Part #	Mounting Screws	Color of Lens	U/M	Sug.Retail
201410	M10	Orange	PR	\$68.25
201411	M10	Clear	PR	\$68.25
201412	M10	Smoke	PR	\$68.25
201413	M10	Mirror	PR	\$70.35
201400	M8	Orange	PR	\$68.25
201401	M8	Clear	PR	\$68.25
201402	M8	Smoke	PR	\$68.25
201403	M8	Mirror	PR	\$70.35

### Brimmed Rim BLACK



Part #	Mounting Screws	Color of Lens	U/M	Sug.Retail
201410-BK	M10	Orange	PR	\$78.75
201411-BK	M10	Clear	PR	\$78.75
201412-BK	M10	Smoke	PR	\$78.75
201413-BK	M10	Mirror	PR	\$80.85
201400-BK	M8	Orange	PR	\$78.75
201401-BK	M8	Clear	PR	\$78.75
201402-BK	M8	Smoke	PR	\$78.75
201403-BK	M8	Mirror	PR	\$80.75

### Brimmed Rim "Chopper"



Part #	Mounting Screws	Color of Lens	U/M	Sug.Retail
201460	M10	Orange	PR	\$68.25
201461	M10	Clear	PR	\$68.25
201462	M10	Smoke	PR	\$68.25
201450	M8	Orange	PR	\$68.25
201451	M8	Clear	PR	\$68.25
201452	M8	Smoke	PR	\$68.25

### Brimmed Rim "Neo"

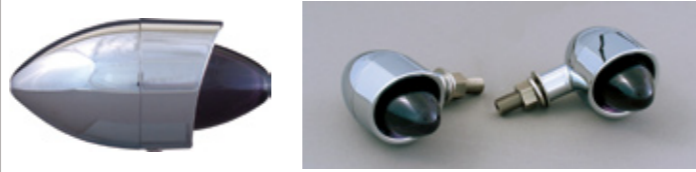

Part #	Mounting Screws	Color of Lens	U/M	Sug.Retail
201480	M10	Orange	PR	\$68.25
201481	M10	Clear	PR	\$68.25
201482	M10	Smoke	PR	\$68.25
201470	M8	Orange	PR	\$68.25
201471	M8	Clear	PR	\$68.25
201472	M8	Smoke	PR	\$68.25

This page items are



## Mounting Hardware for Turn Signals



### For "Sportster"

Part #	Corresponding Motorcycle	Turn Signal Type	Color of Lens	Sug.Retail
882410	Sportster	Brimmed Rim	Orange	\$182.70
882411	Sportster	Brimmed Rim	Clear	\$182.70
882412	Sportster	Brimmed Rim	Smoke	\$182.70
882413	Sportster	Brimmed Rim	Mirror	\$186.90
882460	Sportster	"Chopper"	Orange	\$182.70
882461	Sportster	"Chopper"	Clear	\$182.70
882462	Sportster	"Chopper"	Smoke	\$182.70
882480	Sportster	Brimmed Rim"Neo"	Orange	\$182.70
882481	Sportster	Brimmed Rim"Neo"	Clear	\$182.70
882482	Sportster	Brimmed Rim"Neo"	Smoke	\$182.70
882510	Sportster	"New School"	Orange	\$182.70
882511	Sportster	"New School"	Clear	\$182.70
882512	Sportster	"New School"	Smoke	\$182.70
882513	Sportster	"New School"	Mirror	\$186.90
882560	Sportster	"Chopper"	Orange	\$182.70
882561	Sportster	"Chopper"	Clear	\$182.70
882562	Sportster	"Chopper"	Smoke	\$182.70
882580	Sportster	"Neo Chopper"	Orange	\$182.70
882581	Sportster	"Neo Chopper"	Clear	\$182.70
882582	Sportster	"Neo Chopper"	Smoke	\$182.70



### For "Softail" & "Dyna-Frame" Models

Part #	Corresponding Motorcycle	Turn Signal Type	Color of Lens	Sug.Retail
885410	Softail/Dyna	Bar/Brimmed Rim	Orange	\$306.60
885411	Softail/Dyna	Bar/Brimmed Rim	Clear	\$306.60
885412	Softail/Dyna	Bar/Brimmed Rim	Smoke	\$306.60
885413	Softail/Dyna	Bar/Brimmed Rim	Mirror	\$310.80
885460	Softail/Dyna	Bar/"Chopper"	Orange	\$306.60
885461	Softail/Dyna	Bar/"Chopper"	Clear	\$306.60
885462	Softail/Dyna	Bar/"Chopper"	Smoke	\$306.60
885480	Softail/Dyna	Bar/Brimmed Rim"Neo"	Orange	\$306.60
885481	Softail/Dyna	Bar/Brimmed Rim"Neo"	Clear	\$306.60
885482	Softail/Dyna	Bar/Brimmed Rim"Neo"	Smoke	\$306.60
885510	Softail/Dyna	Bar/"New School"	Orange	\$306.60
885511	Softail/Dyna	Bar/"New School"	Clear	\$306.60
885512	Softail/Dyna	Bar/"New School"	Smoke	\$306.60
885513	Softail/Dyna	Bar/"New School"	Mirror	\$310.80
885560	Softail/Dyna	Bar/"Chopper"	Orange	\$306.60
885561	Softail/Dyna	Bar/"Chopper"	Clear	\$306.60
885562	Softail/Dyna	Bar/"Chopper"	Smoke	\$306.60
885580	Softail/Dyna	Bar/"Neo Chopper"	Orange	\$306.60
885581	Softail/Dyna	Bar/"Neo Chopper"	Clear	\$306.60
885582	Softail/Dyna	Bar/"Neo Chopper"	Smoke	\$306.60

### "New School"



Part #	Mounting Screws	Color of Lens	U/M	Sug.Retail
201510	M10	Orange	PR	\$68.25
201511	M10	Clear	PR	\$68.25
201512	M10	Smoke	PR	\$68.25
201513	M10	Mirror	PR	\$70.35
201500	M8	Orange	PR	\$68.25
201501	M8	Clear	PR	\$68.25
201502	M8	Smoke	PR	\$68.25
201503	M8	Mirror	PR	\$70.35

### "Chopper"

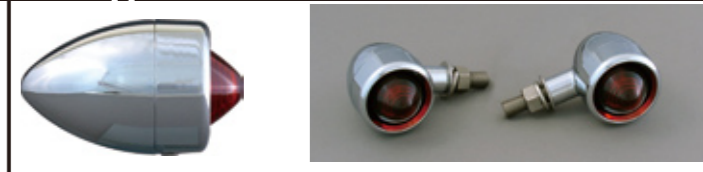

Part #	Mounting Screws	Color of Lens	U/M	Sug.Retail
201560	M10	Orange	PR	\$68.25
201561	M10	Clear	PR	\$68.25
201562	M10	Smoke	PR	\$68.25
201550	M8	Orange	PR	\$68.25
201551	M8	Clear	PR	\$68.25
201552	M8	Smoke	PR	\$68.25

### "Neo Chopper"



Part #	Mounting Screws	Color of Lens	U/M	Sug.Retail
201580	M10	Orange	PR	\$68.25
201581	M10	Clear	PR	\$68.25
201582	M10	Smoke	PR	\$68.25
201570	M8	Orange	PR	\$68.25
201571	M8	Clear	PR	\$68.25
201572	M8	Smoke	PR	\$68.25

This page items are



### Mounting Stem for H.D. Genuine Parts

This mounting stem connects "Front Turn Signal Mounting Bracket and Bar" (part # 884216) to genuine turn signals of Harley-Davidson Deuce.

Sold in Pair

Part # 884217 Sug.Retail \$29.40



### Front Turn Signal Mounting Bracket and Bar

A bracket and bars mounted to front turn signal lights. The size for mounting screws is 10M.

※ The corresponding motorcycles are Softail ('96 ~) and Dyna-Frame

Part # 884216 Sug.Retail \$165.90



# "LED" Turn Signal Light

## "LED" Brimmed Rim Model



This page items are



- 1) Bolts and washers are made of stainless steel.
- 2) In consideration of weep holes, the turn signal lights are designed differently for right and left side
- 3) M10 and M8 bolts are available for mounting.

### "LED" Brimmed Rim BLACK



Part #	Mounting Screws	Color of Lens	U/M	Sug.Retail
205410-BK	M10	Orange	PR	\$115.50
205411-BK	M10	Clear	PR	\$115.50
205412-BK	M10	Smoke	PR	\$115.50
205413-BK	M10	Mirror	PR	\$117.60
205400-BK	M8	Orange	PR	\$115.50
205401-BK	M8	Clear	PR	\$115.50
205402-BK	M8	Smoke	PR	\$115.50
205403-BK	M8	Mirror	PR	\$117.60

### "LED" Brimmed Rim



Part #	Mounting Screws	Color of Lens	U/M	Sug.Retail
205410	M10	Orange	PR	\$105.00
205411	M10	Clear	PR	\$105.00
205412	M10	Smoke	PR	\$105.00
205413	M10	Mirror	PR	\$107.10
205400	M8	Orange	PR	\$105.00
205401	M8	Clear	PR	\$105.00
205402	M8	Smoke	PR	\$105.00
205403	M8	Mirror	PR	\$107.10

### "LED" "New School"

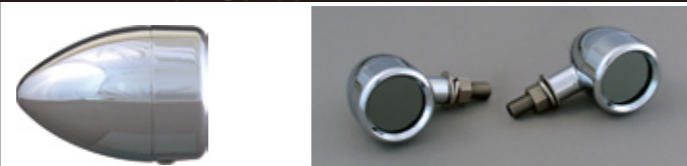

Part #	Mounting Screws	Color of Lens	U/M	Sug.Retail
205510	M10	Orange	PR	\$105.00
205511	M10	Clear	PR	\$105.00
205512	M10	Smoke	PR	\$105.00
205513	M10	Mirror	PR	\$107.10
205500	M8	Orange	PR	\$105.00
205501	M8	Clear	PR	\$105.00
205502	M8	Smoke	PR	\$105.00
205503	M8	Mirror	PR	\$107.10

### "LED" Brimmed Rim "Chopper"



Part #	Mounting Screws	Color of Lens	U/M	Sug.Retail
205460	M10	Orange	PR	\$105.00
205461	M10	Clear	PR	\$105.00
205462	M10	Smoke	PR	\$105.00
205450	M8	Orange	PR	\$105.00
205451	M8	Clear	PR	\$105.00
205452	M8	Smoke	PR	\$105.00

### "LED" "Chopper"

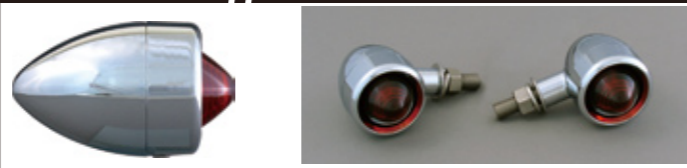

Part #	Mounting Screws	Color of Lens	U/M	Sug.Retail
205560	M10	Orange	PR	\$105.00
205561	M10	Clear	PR	\$105.00
205562	M10	Smoke	PR	\$105.00
205550	M8	Orange	PR	\$105.00
205551	M8	Clear	PR	\$105.00
205552	M8	Smoke	PR	\$105.00

### "LED" Brimmed Rim "Neo"



Part #	Mounting Screws	Color of Lens	U/M	Sug.Retail
205480	M10	Orange	PR	\$105.00
205481	M10	Clear	PR	\$105.00
205482	M10	Smoke	PR	\$105.00
205470	M8	Orange	PR	\$105.00
205471	M8	Clear	PR	\$105.00
205472	M8	Smoke	PR	\$105.00

### "LED" "Neo Chopper"

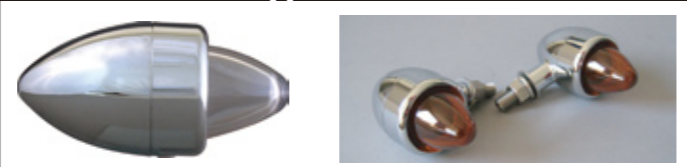

Part #	Mounting Screws	Color of Lens	U/M	Sug.Retail
205580	M10	Orange	PR	\$105.00
205581	M10	Clear	PR	\$105.00
205582	M10	Smoke	PR	\$105.00
205570	M8	Orange	PR	\$105.00
205571	M8	Clear	PR	\$105.00
205572	M8	Smoke	PR	\$105.00

## Replacement parts



● Replacement Lens for "Brimmed Rim" & "New School"

Part #	Color	U/M	Sug.Retail
200400-02	Orange	Each	\$5.25
200401-02	Clear	Each	\$5.25
200402-02	Smoke	Each	\$5.25
200403-02	Mirror	Each	\$6.30



● Replacement Lens for "Brimmed Rim Chopper" & "Chopper"

Part #	Color	U/M	Sug.Retail
200450-02	Orange	Each	\$5.25
200451-02	Clear	Each	\$5.25
200452-02	Smoke	Each	\$5.25



● Replacement Lens for "Brimmed Rim Neo" & "Neo Chopper"

Part #	Color	U/M	Sug.Retail
200470-02	Orange	Each	\$5.25
200471-02	Clear	Each	\$5.25
200472-02	Smoke	Each	\$5.25



● Replacement Gaskets for "Brimmed Rim", "New School", "Brimmed Rim Chopper" & "Chopper", "Brimmed Rim Neo" & "Neo Chopper"

Part #	U/M	Sug.Retail
200400-03	Pear	\$4.20

● Replacement LED Unit for "Brimmed Rim", "New School", "Brimmed Rim Chopper" & "Chopper", "Brimmed Rim Neo" & "Neo Chopper"

Part #	U/M	Sug.Retail
205400-05	Each	\$18.90



● Replacement Socket for "Brimmed Rim", "New School", "Brimmed Rim Chopper" & "Chopper", "Brimmed Rim Neo" & "Neo Chopper"

Part #	U/M	Sug.Retail
201400-05	Each	\$6.30

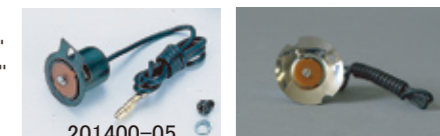

● Replacement Taper Collar for "Brimmed Rim", "New School", "Brimmed Rim Chopper" & "Chopper", "Brimmed Rim Neo" & "Neo Chopper"

Part #	Bolt Size	U/M	Sug.Retail
200400-09	M8	Pear	\$6.30
200410-09	M10	Pear	\$6.30



● Replacement Rim Screws for "Brimmed Rim", "New School", "Brimmed Rim Chopper" & "Chopper", "Brimmed Rim Neo" & "Neo Chopper"

Part #	U/M	Sug.Retail
200400-04	4pcs	\$1.89



● Replacement Cap for "New School", "Chopper", "Neo Chopper"

Part #	U/M	Sug.Retail
201500-10	Each	\$8.93



● Replacement Cap for "Brimmed Rim", "Brimmed Rim Chopper", "Brimmed Rim Neo"

Part #	U/M	Sug.Retail
201400-10	Each	\$8.93



## Brimmed Rim Lens for DEUS Type Turn Signal

Coming Soon



- Fits stock signal housings with stock bulbs.
- Installation is a "Snap" and requires no tools.
- Sold in pears



Part #	Color of Lens	U/M	Sug.Retail
-	Orange	Pear	\$60.90
-	Smoke	Pear	\$60.90



# Turn Signal Light

## Machined Billet Aluminum Model

Turn signal lights machined from billet aluminum have been very popular in every motorcycle show, and they finally come up as our product lineup. A unique luster of aluminum adds a premium and matured accent. Anodized silver and black for colors and ten types of lenses are available, and they will match various kinds of motorcycle custom building.

[The title for each product signifies the differences in shapes of lenses]

Screws in mounting hardware are M8



This page items are



This page items are



## Prism Shaped Model

The concept for this model is psychedelic, and the design is modest in size and sharp. ADC6, which is often used for marine vessel, is the main material for this model. ADC6 contains much magnesium and is corrosive resistant and burst-proof. The mounting hardware such as washers and nuts are, not to mention, all made of stainless steel. Your satisfaction with high quality of POSH products is guaranteed.

※ Repair Parts such as lenses and O-rings are available.



### Billet Aluminum "New School"

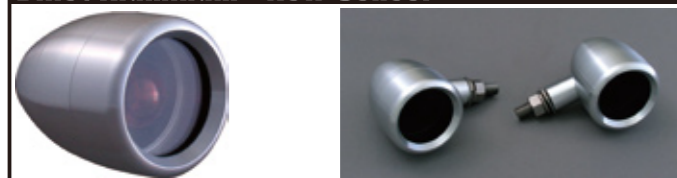

Part #	Color of Lens	U/M	Sug.Retail
200500-SA	Orange	PR	\$126.00
200501-SA	Clear	PR	\$126.00
200502-SA	Smoke	PR	\$126.00
200503-SA	Mirror	PR	\$128.10

### Billet Aluminum "New School" BLACK

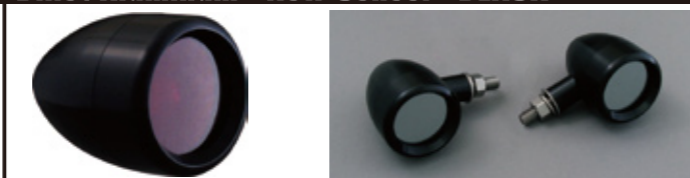

Part #	Color of Lens	U/M	Sug.Retail
200500-BA	Orange	PR	\$126.00
200501-BA	Clear	PR	\$126.00
200502-BA	Smoke	PR	\$126.00
200503-BA	Mirror	PR	\$128.10

### Billet Aluminum "Chopper"

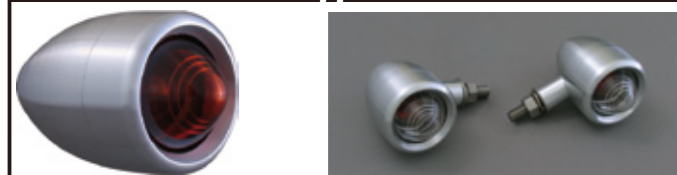

Part #	Color of Lens	U/M	Sug.Retail
200550-SA	Orange	PR	\$126.00
200551-SA	Clear	PR	\$126.00
200552-SA	Smoke	PR	\$126.00

### Billet Aluminum "Chopper" BLACK

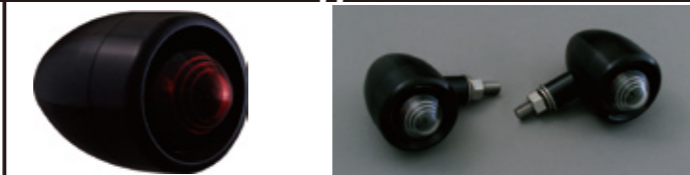

Part #	Color of Lens	U/M	Sug.Retail
200550-BA	Orange	PR	\$126.00
200551-BA	Clear	PR	\$126.00
200552-BA	Smoke	PR	\$126.00

### Billet Aluminum "Neo Chopper"

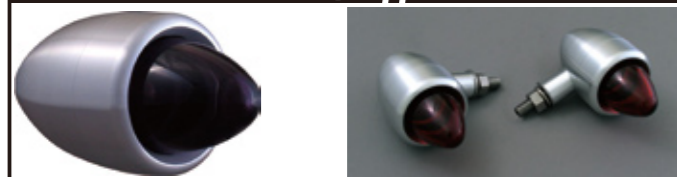

Part #	Color of Lens	U/M	Sug.Retail
200570-SA	Orange	PR	\$126.00
200571-SA	Clear	PR	\$126.00
200572-SA	Smoke	PR	\$126.00

### Billet Aluminum "Neo Chopper" BLACK

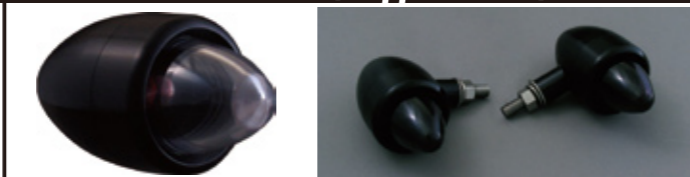

Part #	Color of Lens	U/M	Sug.Retail
200570-BA	Orange	PR	\$126.00
200571-BA	Clear	PR	\$126.00
200572-BA	Smoke	PR	\$126.00

### Billet Aluminum Mounting Brackets for Front Signals



Choosing mounting brackets made of the same material as that of turn signal lights must be preferable. Mounting brackets machined from billet aluminum are now released with the turn signal lights. The surface with alumite processing is weather-resistant.

※ The corresponding motorcycles are Softail ('96~) and Dyna-Frame.  
※ Turn Signals Not Included.

Part #	Mounting Screws	Finish	Sug.Retail
884215-BA	M8	Anodized Black	\$165.90
884215-SA	M8	Anodized White	\$165.90

### Prism [Amber Lens]

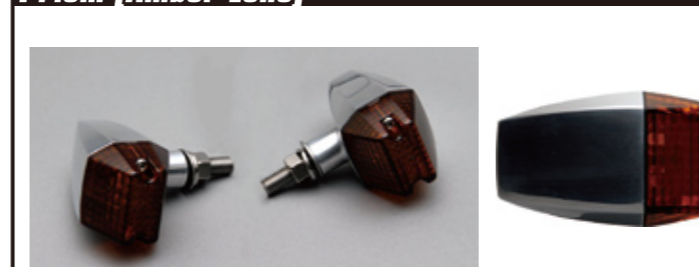

### Prism [Smoke Lens]

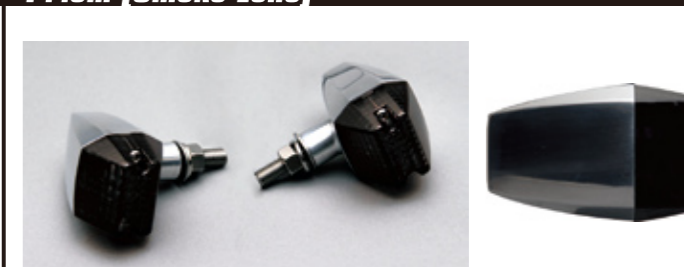

Part #	Mounting Screws	Color of Lens	U/M	Sug.Retail
200520	M8	Orange	PR	\$60.90
200521	M8	Clear	PR	\$60.90
200522	M8	Smoke	PR	\$60.90
200530	M10	Orange	PR	\$60.90
200531	M10	Clear	PR	\$60.90
200532	M10	Smoke	PR	\$60.90

### Prism [Clear Lens]

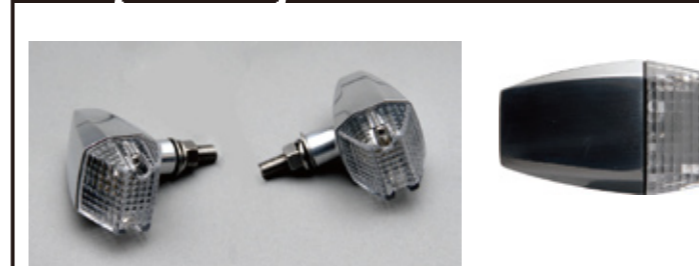

### Front Turn Signal Mounting Bracket and Bar



A bracket and bars mounted to front turn signal lights. The size for mounting screws is M8.

※ The corresponding motorcycles are Softail ('96~) and Dyna-Frame

Part #	884215-BF	Sug.Retail	\$165.90
--------	-----------	------------	----------

Machined aluminum finishing with polished.

## Universal Parts

### Protection Spiral Tube (2m/1pack)

Flame retardant nylon tubes are used for cover mesh hoses or put cables together. It matches hydraulic hoses in 2# and 3# size.

Part #	Color	Sug.Retail
800300	White	\$8.40(2m/1pac)
800301	Black	\$8.40(2m/1pac)
800302	Red	\$8.40(2m/1pac)
800303	Blue	\$8.40(2m/1pac)
800304	Purple	\$8.40(2m/1pac)
800305	Fluorescent Yellow	\$8.40(2m/1pac)
800306	Fluorescent Orange	\$8.40(2m/1pac)
800307	Fluorescent Pink	\$8.40(2m/1pac)
800308	Yellow	\$8.40(2m/1pac)
800309	Vapor Deposition	\$10.50 (1m/1pac)



### Double Head Tie

2 loops of figure 8 can be made with this tie. This tie is very useful to tie parallel 2 different types of wires or hoses.

Part #	Color	Size/pc	Sug.Retail
880270	White	M(208mm)/5pc	\$4.20
880271	Black	M(208mm)/5pc	\$4.20
880280	White	L(397mm)/5pc	\$5.25
880281	Black	L(397mm)/5pc	\$5.25



### One way valve for breather pipe

The body made of machined billet aluminum with nylon cubes realizes accurate control. It fits hoses in I.D. 6mm.

Part #	Color	Sug.Retail
200100	Blue	\$10.50
200101	Red	\$10.50
200102	Purple	\$10.50
200103	Titanium Color	\$10.50



### Stainless-steel Hose Clamp

A durable hose clamp with stainless steel screws.

Part #	Inside diameter	Sug.Retail
800610	φ8~10mm	\$6.30(2pcs)
800612	φ10~12mm	\$6.30(2pcs)



### One-touch Fuel Hose Joint

If you frequently remove a fuel tank for maintenance or setting, this hose joint is very useful. A built-in shut-off valve minimizes the leak of gasoline when removing fuel tank.

Part #	Inside Diameter	Sug.Retail
800052	φ5mm	\$33.60
800053	φ6mm	\$33.60
800054	φ8mm	\$33.60



### Colored Fuel Hose

A half transparent resin hose with high oil resistance and anti-weatherability. The whole length is all 50cm, and hoses in three kinds of inner diameters are available.



φ5mm	φ6mm	φ8mm	Color	Sug.Retail
800340	800350	800360	Blue	\$6.30
800341	800351	800361	Red	\$6.30
800342	800352	800362	Yellow	\$6.30
800343	800353	800363	Purple	\$6.30
800344	800354	800364	Green	\$6.30

### Slim Reflectors

Reflector are adhesive backed OE type.

Part #	U/M	Sug.Retail
800094	Each	\$9.24

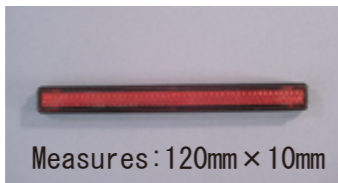

INSULOK ties with high handiness, intensity, and durability are must-have for racing mechanics. 15 ties or 100 ties in one set with various colors is available.

※INSULOK is a trademark registration of Helleman Tyton

Size	Color	Part # (15 ties)	Sug.Retail	Size	Color	Part # (15 ties)	Sug.Retail	Size	Color	Part # (15 ties)	Sug.Retail
S 100mm	White	800200	\$2.63	M 152mm	White	800210	\$3.15	L 251mm	White	800220	\$6.30
S 100mm	Black	800201	\$3.15	M 152mm	Black	800211	\$4.20	L 251mm	Black	800221	\$7.35
S 100mm	Red	800202	\$3.15	M 152mm	Red	800212	\$4.20	L 251mm	Blue	800222	\$7.35
S 100mm	Blue	800203	\$3.15	M 152mm	Blue	800213	\$4.20	L 251mm	Red	800223	\$7.35
S 100mm	Fluorescent Yellow	800204	\$3.15	M 152mm	Purple	800214	\$4.20				
S 100mm	Fluorescent Orange	800205	\$3.15	M 152mm	Fluorescent yellow	800215	\$4.20				
S 100mm	Fluorescent Pink	800206	\$3.15	M 152mm	Fluorescent orange	800216	\$4.20				
				M 152mm	Fluorescent pink	800217	\$4.20				

Size	Color	Part # (100ties)	Sug.Retail	Size	Color	Part # (100ties)	Sug.Retail	Size	Color	Part # (100ties)	Sug.Retail
S 100mm	White	800240	\$4.20	M 152mm	White	800250	\$8.40	L 251mm	white	800260	\$21.00
S 100mm	Black	800241	\$6.30	M 152mm	Black	800251	\$12.60	L 251mm	Black	800261	\$31.50
S 100mm	Red	800242	\$6.30	M 152mm	Red	800252	\$12.60	L 251mm	Blue	800262	\$31.50
S 100mm	Blue	800243	\$6.30	M 152mm	Blue	800253	\$12.60	L 251mm	Red	800263	\$31.50
S 100mm	Fluorescent Yellow	800244	\$6.30	M 152mm	Purple	800254	\$12.60				
S 100mm	Fluorescent Orange	800245	\$6.30	M 152mm	Fluorescent yellow	800255	\$12.60				
S 100mm	Fluorescent Pink	800246	\$6.30	M 152mm	Fluorescent orange	800256	\$12.60				
				M 152mm	Fluorescent pink	800257	\$12.60				



# POSH Faith brand



36  
Turn Signal Light

38  
Meter Line

40  
Light & Reflector

42  
Rearview Mirror

44  
Universal Parts & Tools

46  
Stainless Bolt

A lineup of turn signal lights with unique texture of machined billet aluminum. The sharp luster matches future-oriented custom building. A screw-in bracket eliminates fixing bolts in the body part and gives a much shaper impression of contour.

# Turn Signal Light

This lineup of turn signal lights is designed with versatility. It fits any kind of motorcycles with a right choice of Bulbes, screws, and wiring position. Various kinds of shapes, materials, lens colors, and lens sizes are available. It will definitely help your own custom building. \* Sold in pairs

## Basic Body Series

A lineup of turn signal light with new concept. Chrome housings body & "Snap" in lenses. This is Japanese new standard!

This page items are



### Basic Body (Type71)



※Bulb Not Included

Part #	Socket	Bub	U/M	Sug. Retail
094091	Single	Not Included	PR	\$58.00
094092	Single	Not Included	PR	\$58.00
094491	Dual	Not Included	PR	\$61.00
094492	Dual	Not Included	PR	\$61.00

### Basic Body (Bullet Type)

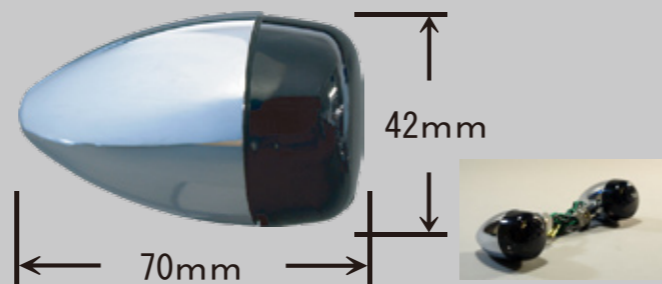

※Bulb Not Included

Part #	Socket	Bub	U/M	Sug. Retail
094098	Single	Not Included	PR	\$58.00
094099	Single	Not Included	PR	\$58.00
094498	Dual	Not Included	PR	\$61.00
094499	Dual	Not Included	PR	\$61.00

### Classical Body (Type71)

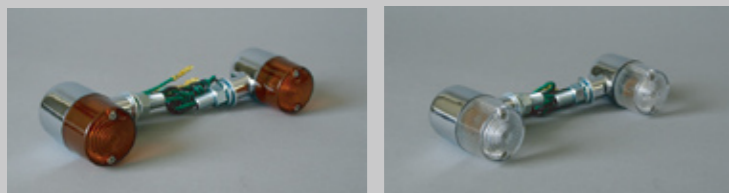
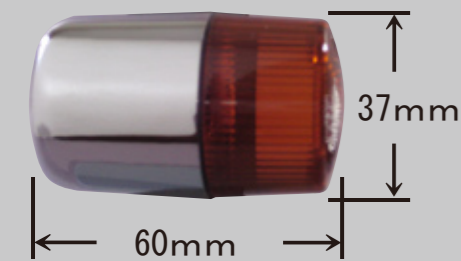

Part #	Socket	Bub	U/M	Sug. Retail
095091	Single	Not Included	PR	\$50.40
095092	Single	Not Included	PR	\$50.40
095491	Dual	Not Included	PR	\$53.55
095492	Dual	Not Included	PR	\$53.55

### Classical Body (Bullet Type)

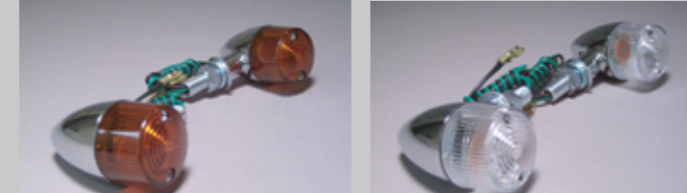
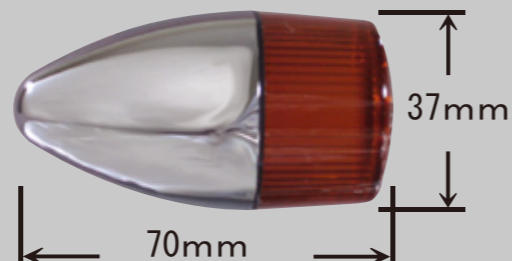

Part #	Socket	Bub	U/M	Sug. Retail
095091	Single	Not Included	PR	\$50.40
095092	Single	Not Included	PR	\$50.40
095491	Dual	Not Included	PR	\$53.55
095492	Dual	Not Included	PR	\$53.55

## Aluminum Machined-body Series

A lineup of turn signal lights with unique texture of machined billet aluminum. The sharp luster matches future-oriented custom building. A screw-in bracket eliminates fixing bolts in the body part and gives a much shaper impression of contour.

This page items are



### Aluminum Machined Body (Type71)

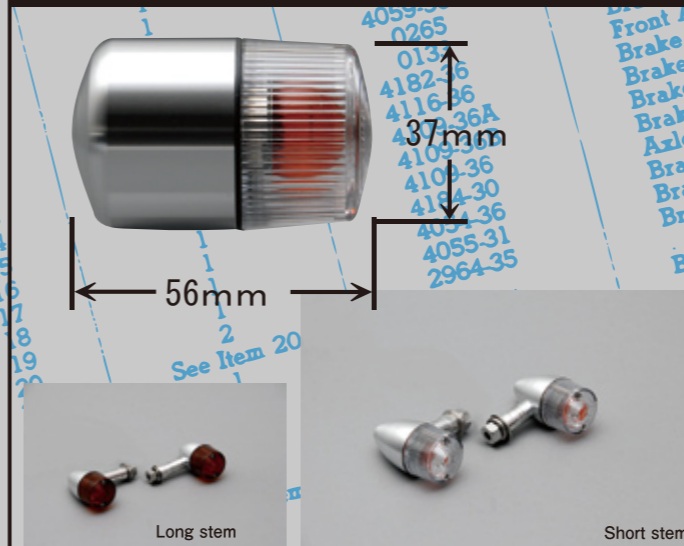

Part#/Long	Part#/Short	Bulb	Lens	U/M	Sug. Retail
090091-23	090092-23	Single 23W	Amber	PR	\$56.70
090191-23	090192-23	Single 23W	Clear	PR	\$60.90
090491-23	090492-23	W 23/8W	Amber	PR	\$59.85
090591-23	090592-23	W 23/8W	Clear	PR	\$64.05
091091-23	091092-23	S Nothing	Amber	PR	\$54.60
091191-23	091192-23	S Nothing	Clear	PR	\$54.60
091491-23	091492-23	W Nothing	Amber	PR	\$56.70
091591-23	091592-23	W Nothing	Clear	PR	\$56.70

### Aluminum Machined Body (Bullet Type)

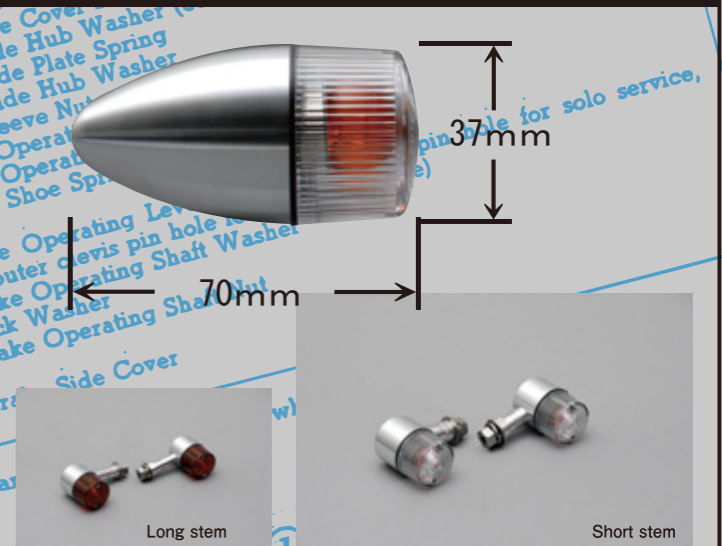

Part#/Long	Part#/short	Bulb	Lens	U/M	Sug. Retail
090098-23	090099-23	Single 23W	Amber	PR	\$59.85
090198-23	090199-23	Single 23W	Clear	PR	\$64.05
090498-23	090499-23	W 23/8W	Amber	PR	\$63.00
090598-23	090599-23	W 23/8W	Clear	PR	\$67.20
091098-23	091099-23	S Nothing	Amber	PR	\$57.75
091198-23	091199-23	S Nothing	Clear	PR	\$57.75
091498-23	091499-23	W Nothing	Amber	PR	\$59.85
091598-23	091599-23	W Nothing	Clear	PR	\$59.85

### Aluminum Machined Body (Super Bike Type)

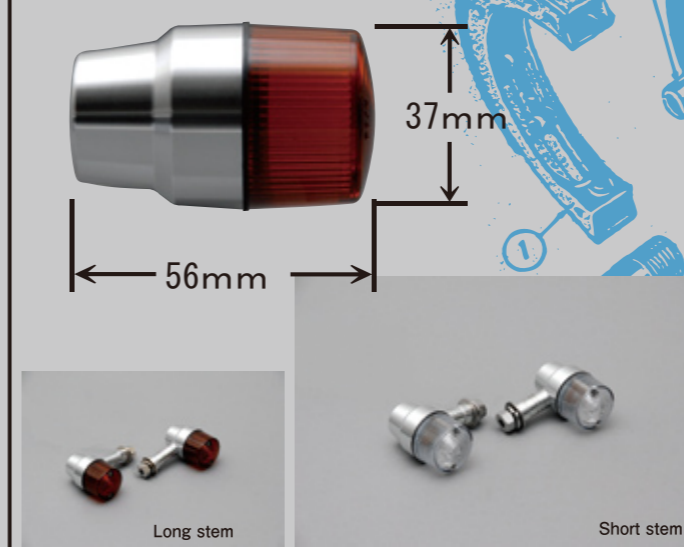

Part#/Long	Part#/short	Bulb	Lens	U/M	Sug. Retail
090032-23	090033-23	Single 23W	Amber	PR	\$59.85
090132-23	090133-23	Single 23W	Clear	PR	\$64.05
090432-23	090433-23	W 23/8W	Amber	PR	\$63.00
090532-23	090533-23	W 23/8W	Clear	PR	\$67.20
091032-23	091033-23	S Nothing	Amber	PR	\$57.75
091132-23	091133-23	S Nothing	Clear	PR	\$57.75
091432-23	091433-23	W Nothing	Amber	PR	\$59.85
091532-23	091533-23	W Nothing	Clear	PR	\$59.85

### Repair Parts

Lens, O-rings, Screws, Bulb Socket

●Repair Lens (2pcs)

Part#	Body Size	Color	Sug. Retail
090071-SP	STD	Amber	\$4.72
090171-SP	STD	Clear	\$4.72
090271-SP	STD	Smoke	\$5.25
090371-SP	STD	Blue-Clear	\$5.25

●Repair Bulb Socket

Part#	Body Size	Sug. Retail
090071-SK	STD	\$3.67

●Repair O-Ring (2pcs)

Part#	Body Size	Sug. Retail
090071-P	STD	\$1.26
092071-P	Middle	\$1.26

●Repair Screws for Lens (4pcs)

Part#	Body Size	Sug. Retail
090071-BS	Common use	\$1.89

# Meter Line

The product lineup of "MINI" series with indicators in 67mm diameter and "MINI-MINI" series with indicators in 53mm diameter. You can choose LED lights or normal bulbs for a backup light. The indicator case is made of stainless steel (some are not), and mounting hardware is available. "Neo-Classic Meter Line", which is very popular for vintage-type lovers, is available, too.



## LED Back-Light "Mini Speed" with 4-Indicator Lamp LED Back-Light "Mini-Mini" Voltage Indicator



LED back-light "Mini Speed" with 4-indicator lamp. Built-in mini-indicators displaying 140km/h, four indicator lamps, and a trip meter. The four lamps, blue, green, red, and yellow respectively correspond to high beam, neutral, oil, and turning.  
 ※ Indicators correspond to motorcycle's lightning function.  
 ※ Basically waterproof to withstand raining, but please do not submerge it.

Part #	Panel Color	Sug.Retail
000014-80	White	\$105.00
000014-81	Blue	\$105.00
000014-82	Red	\$105.00
000014-83	Yellow	\$105.00
000014-86	Black	\$105.00



Small voltage indicator built in the body of "Mini-Mini" meter. Only white is available for the panel, but you can choose blue or white for the LED backup light.  
 ※ Basically waterproof to withstand rain, but please do not submerge it.  
 ※ Meets the standard in Japan

Part #	Panel Color	Sug.Retail
000091-60	White	\$50.40
000091-61	Blue	\$50.40

## LED Back-Light Speed Meter "Mini"



Built in mini-indicator displaying 140km/h and a trip meter. Simplicity-conscience indicator. Five colors are available for the panel.  
 ※ Basically waterproof to withstand raining, but please do not submerge it.  
 ※ <60km/h:1400rpm> It meets the standard in Japan.

Part #	Panel Color	Sug.Retail
000014-70	White	\$84.00
000014-71	Blue	\$84.00
000014-72	Red	\$84.00
000014-73	Yellow	\$84.00
000014-76	Black	\$84.00

## Speed Meter "Neo-Classic"



Built in mini-indicator displaying 140km/h and a trip meter. Simplicity-conscience indicator. Five colors are available for the panel.  
 ※ Basically waterproof to withstand raining, but please do not submerge it.  
 ※ <60km/h:1400rpm> It meets the standard in Japan.

Part #	Panel Color	Sug.Retail
000018	Black	\$78.75

## Speed Meter "Mini" 220km/h Scale

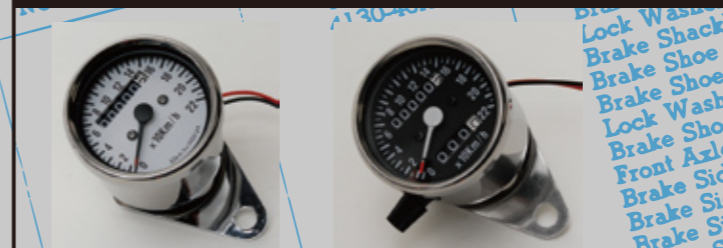

A mini-indicator of 220km/h full scale with/without a trip meter.  
 ※ There is no black panel for an indicator without a trip meter.  
 ※ Basically waterproof to withstand raining, but please do not submerge it.  
 ★ <60m/h X 140rpm> It meets the standard in Japan.

Part #	Panel Color	Trip meter	Sug.Retail
000011-10	White	-----	\$57.75
000012	Black	Attachment	SOLD OUT
000012-10	White	Attachment	SOLD OUT

## Speed Meter "Mini" 140km/h Scale

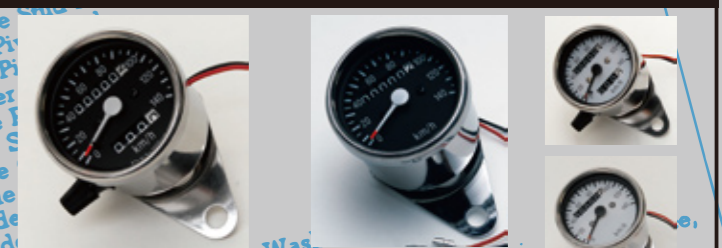

A mini-indicator of 140km/h scale with/without a trip meter. Black and white color is available for the panel.  
 ※ Basically waterproof to withstand raining, but please do not submerge it.  
 ★ <60m/h X 140rpm> It meets the standard in Japan.

Part #	Panel Color	Trip meter	Sug.Retail
000013	Black	-----	SOLD OUT
000013-10	White	-----	SOLD OUT
000014	Black	Attachment	\$68.25
000014-10	White	Attachment	\$68.25

## Speed & Tacho Meter "Mini-Mini"



Part #	Panel Color	Trip meter	Sug.Retail
000032	Black	-----	\$57.75
000032-10	White	-----	\$57.75
000030	Black	Tacho	\$57.75
000030-10	White	Tacho	SOLD OUT

## Speed & Tachometer "Combi"

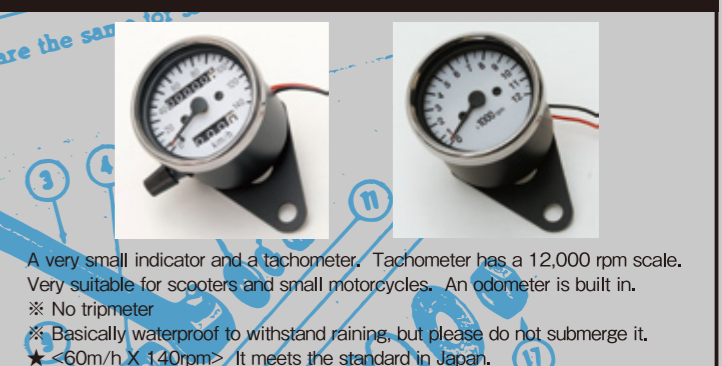

A very small indicator and a tachometer. Tachometer has a 12,000 rpm scale. Very suitable for scooters and small motorcycles. An odometer is built in.  
 ※ No trip meter  
 ※ Basically waterproof to withstand raining, but please do not submerge it.  
 ★ <60m/h X 140rpm> It meets the standard in Japan.

Part #	Function	Sug.Retail
000014-16	Speed	\$63.00
000010-16	Tacho	\$52.50

## LED Back-Light Mechanical Tachometer "Mini"

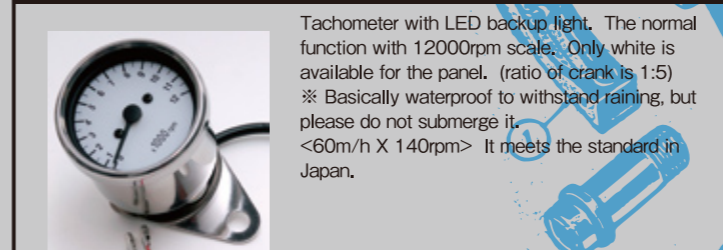

Tachometer with LED backup light. The normal function with 12000rpm scale. Only white is available for the panel. (ratio of crank is 1:5)  
 ※ Basically waterproof to withstand raining, but please do not submerge it.  
 <60m/h X 140rpm> It meets the standard in Japan.

Part #	Sug.Retail
000010-70	\$78.75

## Meter Stay for "Mini" & "Mini-Mini"

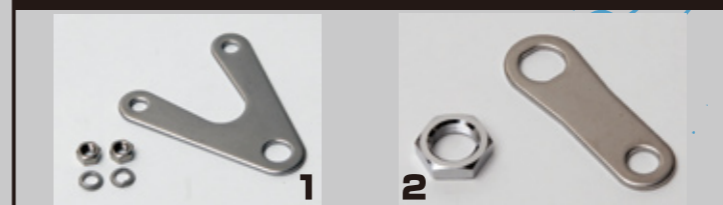

Photo#	Part #	Application	Sug.Retail
1	000010-ST	for "MINI" Meter	\$15.75
2	000030-ST	for "MINI-MINI" Meter	\$10.50

## Repair Parts

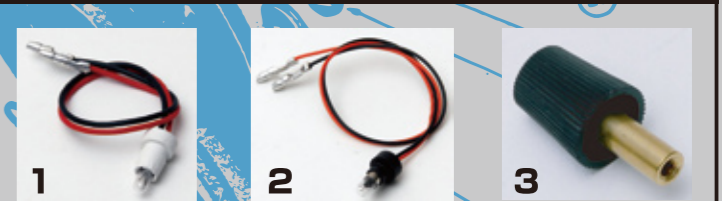

Photo#	Part #	Application	Sug.Retail
1	000010-86	Bulb for "MINI" Meter	\$5.25
2	000030-84	Bulb for "MINI-MINI" Meter	\$5.25
3	010086-NB	Knob for Trip Meter	\$5.25

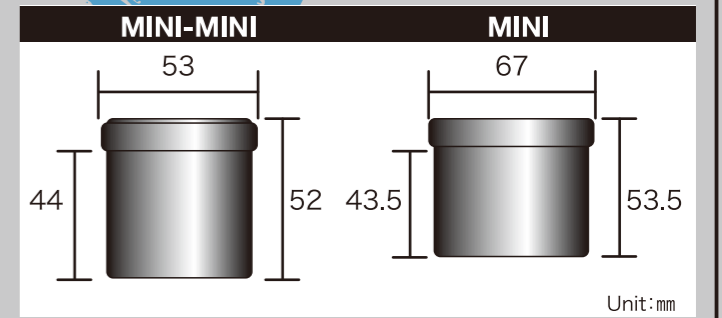

# Lights & Reflectors

These are the product lineup of "Bates" headlights and rear lights that match classical-looking custom-building.

## 4.5-inch Across / "BATES" Type Headlight



This is the most standard model with a lens in 4.5 inch diameter. It has a built-in H4 halogen bulb of 35/35W. Chrome-plated or black plated is available for both the case and the rim, and you can combine both of them.  
★ The diameter of mounting bolts is 10mm

Part #	Case Color	Sug.Retail
000120	Chrome	\$63.00
000120-06	Black	\$63.00
000120-16	Combination	\$63.00

## 5.5-inch Across / "BATES" Type Headlight



The Bates type headlight with a lens in 5.5 inch diameter, and it has built-in H4 halogen bulb of 60/50W. Like the headlight of 4.5 inch lens, chrome-plated or black-plated is available for the case and rim, and you can combine of them.

Part #	Case Color	Sug.Retail
000021	Chrome	\$84.00
000021-06	Black	\$84.00
000021-16	Combination	\$84.00

## 4.5-inch Across / "Diamond" Type Headlight



The combination of a case for 4.5 inch Bates headlights, multi-reflectors, and plain-colored lens. It has a built-in H4 halogen bulb of 35/35W, and two colors, clear and blue, are available for the lens. Orthodox-looking with a black-plated case a chrome-plated rim.

★ The diameter of mounting bolts is 10mm.  
※ Please do not use high-watt bulbs to prevent the product from deforming with heat.

Part #	Lens Color	Sug.Retail
000022	Clear	\$63.00
000024	Blue	\$63.00

## 5.5-inch Across / "Diamond" Type Headlight



The combination of a case for 5.5 inch Bates headlights, multi-reflectors, and plain-colored lens. It has a built-in H4 halogen bulb of 60/50W, and two colors, clear and blue, are available for the lens. Orthodox-looking with a black-plated case a chrome-plated rim.

★ The diameter of mounting bolts is 10mm.  
※ Please do not use high-watt bulbs to prevent the product from deforming with heat.

Part #	Lens Color	Sug.Retail
000023	Clear	\$92.40
000025	Blue	SOLD OUT

## Headlight Lens for Repairing



A lens for a repair used for "Diamond" type headlights. It is also used for Bates type headlights.  
※ Please do not use high-watt bulbs to prevent the product from deforming with heat.

Part #	Lens Size	Lens Color	Sug.Retail
000022-L	4.5inch	Clear	\$23.10
000024-L	4.5inch	Blue	\$23.10
000023-L	5.5inch	Clear	\$36.75
000025-L	5.5inch	Blue	\$36.75

## Vintage Round Shape Taillight

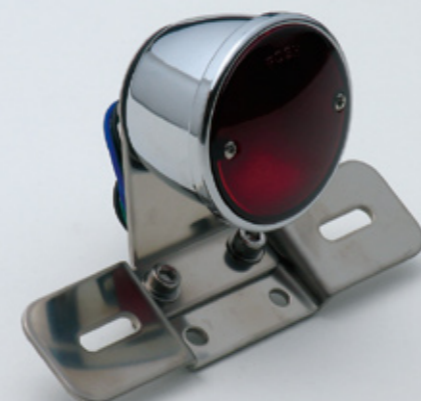

The popular taillight unit with small body and an orthodox round lens. Chrome-plated or black-plated is available for both the light case and the bracket, and you can combine them.  
■ The diameter of the lens: 63mm / the bulb: 12V15W/8W

Part #	Case Color	Sug.Retail
090042-03	Chrome	\$65.10
090042-06	Black	\$65.10
● Lens for repairing, 090042-L		(\$8.40)



## Vintage Tapered Shape Taillight



The popular taillight unit with small body and an orthodox round lens. Chrome-plated or black-plated is available for both the light case and the bracket, and you can combine them.  
■ The diameter of the lens: 63mm / the bulb: 12V15W/8W

Part #	Case Color	Sug.Retail
090044-03	Chrome	SOLD OUT
090044-06	Black	\$67.20
090044-16	Combination	\$72.45
● Lens for repairing, 090042-L		(\$8.40)



## "Cat's eye" Taillight



A standard type as a American aftermarket product. The light case is made of stainless steel and is chrome-plated. The bracket is made of stainless steel.

■ Bulb: 12V15W/8W  
090040-03 Chrome \$65.10  
● Lens for repairing, 090040-L (\$6.30)

## Lucas type Taillight



Very popular taillight that match any kind of styles from toTracker. The base plate is made of aluminum.  
■ Bulb: 12V15W/8W

090045-90	\$29.40
● Lens for Repairing, 011091	(\$6.30)

## "Acute" LED-Taillight



A LED taillight that matches near-futuristic custom-building. As the name "Acute" tells, the shape is sharp. There are 9 red LED with a bracket for a license plate.  
■ Measurement for lenses: width 140mm X height 40mm  
※ No light for a license plate.

090047-91 \$50.40

## "Ivy" LED-Taillight



More simple design with LED taillight. There are 9 red LED lights and 4 LED lights for a license plate.  
■ Measurement for lenses: width 138mm X height 45mm

090048-91 \$50.40

## LED Reflector (Japanese License Plate Size Only)

Reflector with LEDs that enhance nighttime visibility. It can be used as supporting light for stop lamp and position lamp by arranging wiring position. You can choose solely a reflector or reflector with a bracket. Two brackets, angled (mounting angle 45 degree) and straight types, are available.  
 ※The reflecting area is limited.

Part #	Bracket	Sug.Retail
900091	n/a	\$18.90
900091-01	Straight	\$29.40
900091-02	45 Degree	\$29.40



## Square & Circular Reflector (Japanese License Plate Size Only)

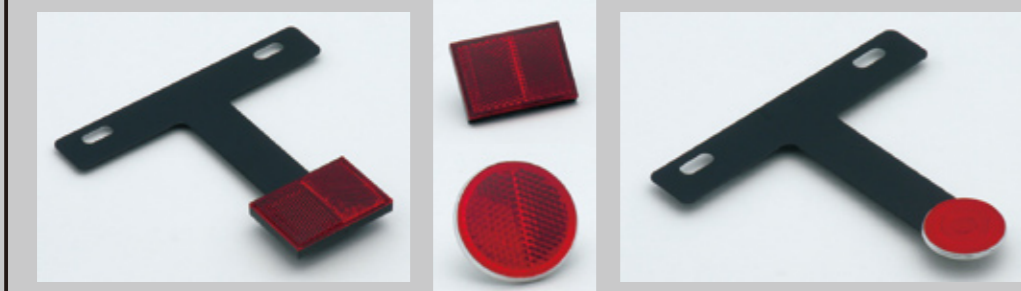

Part #	Reflector	Bracket	Sug.Retail
900090-AK	square	straight	\$16.80
900090-A	square	n/a	\$4.20
900090-RK	circular	straight	\$15.75
900090-R	circular	n/a	\$3.15

## LED Registration plate light & Reflector (Japanese License Plate Size Only)



LED Registration plate light & reflector  
 18 White high-intensity LEDs are located on this license plate kit. It can be mounted with the lighting area facing downward. The mounting angle can be adjustable and the reflector itself is removable. The reflecting area is 17.6cm<sup>2</sup>  
 ※ It does not fit motorcycles with less than 125cc

500094 \$71.40

## Headlight bracket for front fork (clamp type)



Headlight bracket made of steel or stainless steel for front fork. Steel bracket has chrome-plated or black-plated type, and the diameter of fork clamp is 30mm ~39mm. Stainless steel type fits 36mm ~44mm diameter of fork clamp.

Part #	Surface	Sug.Retail
009830-90	NiCr	\$15.75
009830-96	Black	SOLD OUT
009831-ST	Stainless steel	\$36.75

## Aluminum Headlight stay for Front Fork



Luxurious buffed brackets with aluminum. Enjoy the beautiful luster that can be enhanced as you polish it. Depending on a motorcycle type, the bracket may interfere with a tank when you turn the steering wheel.

Part #	Diameter of Fork	Sug.Retail
020176	39mm	SOLD OUT
021176	41mm	SOLD OUT

## (Gio) Headlight Colorant



Transparent colorant for a headlight, taillight, and lenses. The color of lenses can be easily changed by spraying it. You can remove that color with the remover sold separately.

Part #	Color	Sug.Retail
099100-21	Blue	\$19.95
099100-26	Yellow	\$19.95
099100-27	Smoke	\$19.95
099100	Remover	\$6.30

# Casting Mirror

- High quality aluminum die-cast body. Stainless stay and nut to prevent from rusting.
- 1200R convex mirror to keep clear view.
- M10 screw in. (M10 Inversive screw for the right side of YAMAHA models)

## MP21 Casting mirror (3-inch round type)

MADE IN JAPAN

Specification	Mounting screws	Part #	Sug.Retail
Right	M10	001621	\$35.70
Right	M10(CCWS)	001622	\$35.70
Left	M10	001623	\$35.70

Specification	Mounting screws	Part #	Sug.Retail
Right	M10	001721	\$39.90
Right	M10(CCWS)	001722	\$39.90
Left	M10	001723	\$39.90

※[CCWS]=Counter-Clockwise Screws



Mirror Head  $\phi$ 74mm

## MP22 Casting mirror (Vintage oval type)

MADE IN JAPAN

Specification	Mounting screws	Part #	Sug.Retail
Right	M10	001631	\$39.90
Right	M10(CCWS)	001632	\$39.90
Left	M10	001633	\$39.90

Specification	Mounting screws	Part #	Sug.Retail
Right	M10	001731	\$42.00
Right	M10(CCWS)	001732	\$42.00
Left	M10	001733	\$42.00

※[CCWS]=Counter-Clockwise Screws



Mirror Head W104mm x H66mm

## MP23 Casting mirror (Square mini type)

MADE IN JAPAN

Specification	Mounting screws	Part #	Sug.Retail
Right	M10	001641	\$35.70
Right	M10(CCWS)	001642	\$35.70
Left	M10	001643	\$35.70

Specification	Mounting screws	Part #	Sug.Retail
Right	M10	001741	\$39.90
Right	M10(CCWS)	001742	\$39.90
Left	M10	001743	\$39.90

※[CCWS]=Counter-Clockwise Screws



Mirror Head W100mm x H46mm

## MP27 Casting mirror (Vintage round type)

MADE IN JAPAN

Specification	Mounting screws	Part #	Sug.Retail
Right	M10	001651	\$39.90
Right	M10(CCWS)	001652	\$39.90
Left	M10	001653	\$39.90

Specification	Mounting screws	Part #	Sug.Retail
Right	M10	001751	\$42.00
Right	M10(CCWS)	001752	\$42.00
Left	M10	001753	\$42.00

※[CCWS]=Counter-Clockwise Screws



Mirror Head W112mm x H63mm

## MP29 Casting mirror (3.5-inch round type)

MADE IN JAPAN

Specification	Mounting screws	Part #	Sug.Retail
Right	M10	001661	\$39.90
Right	M10(CCWS)	001662	\$39.90
Left	M10	001663	\$39.90

Specification	Mounting screws	Part #	Sug.Retail
Right	M10	001761	\$42.00
Right	M10(CCWS)	001762	\$42.00
Left	M10	001763	\$42.00

※[CCWS]=Counter-Clockwise Screws



Mirror Head  $\phi$ 92mm

## MP31 Casting mirror (Basic square type)

MADE IN JAPAN

Specification	Mounting screws	Part #	Sug.Retail
Right	M10	001671	\$39.90
Right	M10(CCWS)	001672	\$39.90
Left	M10	001673	\$39.90

Specification	Mounting screws	Part #	Sug.Retail
Right	M10	001771	\$42.00
Right	M10(CCWS)	001772	\$42.00
Left	M10	001773	\$42.00

※[CCWS]=Counter-Clockwise Screws



Mirror Head W105mm x H68mm

## Cap Bolt Holder

Machined billet aluminum holders for bolt heads. You can use it as washers for fixing bolts on a resin area of a cowl. M6, M8, and M10 sizes with respectively 8 different colors are available.



MADE IN JAPAN

### for M6 Bolt [4pc]

Color	Part #	Sug.Retail
Chrome-Plated	004086	\$21.00
Blue	004086-01	\$18.90
Red	004086-02	\$18.90
Silver	004086-03	\$18.90
Blueberry	004086-05	\$18.90
Black	004086-06	\$18.90
Titan	004086-11	\$18.90
Campaign Gold	004086-12	\$18.90

### for M8 Bolt [2pc]

Color	Part #	Sug.Retail
Chrome-Plated	004088	\$11.55
Blue	004088-01	\$10.50
Red	004088-02	\$10.50
Silver	004088-03	\$10.50
Blueberry	004088-05	\$10.50
Black	004088-06	\$10.50
Titan	004088-11	\$10.50
Campaign Gold	004088-12	\$10.50

### for M10 Bolt [2pc]

Color	Part #	Sug.Retail
Chrome-Plated	004180	\$12.60
Blue	004180-01	\$12.60
Red	004180-02	\$12.60
Silver	004180-03	\$12.60
Blueberry	004180-05	\$12.60
Black	004180-06	\$12.60
Titan	004180-11	\$12.60
Campaign Gold	004180-12	\$12.60

## Colored Aluminum Caps for Mirror Grooves

Caps to fill unused grooves for mirror mounting. Please select the one that fits the size of mirror screws.

Color	M8/Part #	M10/Part #	M10[inversive screw]/Part #	Sug.Retail
Blue	000810-01	000806-01	000807-01	\$5.25
Red	000810-02	000806-02	000807-02	\$5.25
Silver	000810-03	000806-03	000807-03	\$5.25
Gold	000810-04	000806-04	000807-04	\$5.25
Blueberry	000810-05	000806-05	000807-05	\$5.25
Black	000810-06	000806-06	000807-06	\$5.25



MADE IN JAPAN

## Caps for Mirror Grooves

Caps to fill unused grooves for mirror mounting. Please select the one that fits the size of mirror screws.

Color	M8/Part #	M10/Part #	M10[inversive screw]Part#	Sug.Retail
Chrome-Plated	000811	000808	000809	\$5.25
Blue	000811-01	000808-01	000809-01	\$5.25
Red	000811-02	000808-02	000809-02	\$5.25
Silver	000811-03	000808-03	000809-03	\$5.25
Gold	000811-04	000808-04	000809-04	\$5.25
Black	000811-06	000808-06	000809-06	\$5.25



MADE IN JAPAN

## Cover for cap bolt

A cover that protects the cap bolt head from dirt. It is machined from billet aluminum.

Color	M6 Part #	M8 Part #	M10 Part #	Sug.Retail(4pc)
Chrome-Plated	000822	000820	000821	\$10.29
Blue	000822-01	000820-01	000821-01	\$10.29
Red	000822-02	000820-02	000821-02	\$10.29
Silver	000822-03	000820-03	000821-03	\$10.29
Gold	000822-04	000820-04	000821-04	\$10.29
Black	000822-06	000820-06	000821-06	\$10.29
Titan	000822-11	000820-11	000821-11	\$10.29
Campaign Gold	000822-12	000820-12	000821-12	\$10.29



MADE IN JAPAN

## Net Anchors

Utilizing fixing bolts for rear suspensions and a license plate, a baggage can be tied down with these anchors. [Machining Net Anchor] and [Net Anchor] are available.



### Machining Net Anchor for 6 mm bolts[2pc]

Color	Part #	Sug.Retail
Blue	004006-01	\$12.60
Red	004006-02	\$12.60
Silver	004006-03	\$12.60
Gold	004006-04	\$12.60
Blueberry	004006-05	\$12.60
Black	004006-06	\$12.60
Titan	004006-11	\$12.60
Campaign Gold	004006-12	\$12.60

### Machining Net Anchor for 8 mm bolts[2pc]

Color	Part #	Sug.Retail
Blue	004012-01	\$15.75
Red	004012-02	\$15.75
Silver	004012-03	\$15.75
Blueberry	004012-05	\$15.75
Black	004012-06	\$15.75
Titan	004012-11	\$15.75
Campaign Gold	004012-12	\$15.75

### Net Anchor for 6 mm bolts[2pc]

Color	Part #	Sug.Retail
Blue	004016-01	\$15.75
Red	004016-02	\$15.75
Silver	004016-03	\$15.75
Gold	004016-04	\$15.75
Blueberry	004016-05	\$15.75
Black	004016-06	\$15.75
Titan	004016-11	\$15.75
Campaign Gold	004016-12	\$15.75

### Machining Net Anchor for 6 mm bolts[2pc]

Color	Part #	Sug.Retail
Blue	004022-01	\$18.90
Red	004022-02	\$18.90
Silver	004022-03	\$18.90
Gold	004022-04	\$18.90
Blueberry	004022-05	\$18.90
Black	004022-06	\$18.90
Titan	004022-11	\$18.90
Campaign Gold	004022-12	\$18.90

\* Billet aluminum with alumite finish  
\* With stainless steel cap bolts (M6 X 25mm)

\* Billet aluminum with alumite finish  
\* With stainless steel cap bolts (M8 X 30mm)

\* Billet aluminum with alumite finish  
\* With stainless steel cap bolts (M6 X 25mm)

\* Billet aluminum with alumite finish  
\* With stainless steel cap bolts (M8 X 30mm)

## Colored Aluminum Air Valve Caps

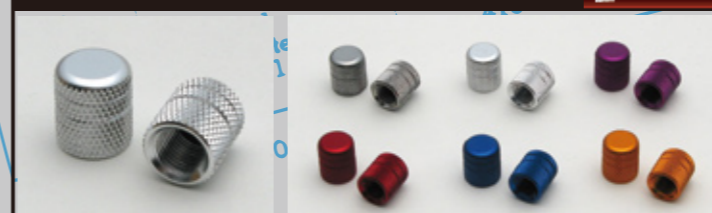

Color	Part #	Sug.Retail(2pc)
Chrome-Plated	000801	\$9.45
Blue	000801-01	\$8.40
Red	000801-02	\$8.40
Silver	000801-03	\$8.40
Gold	000801-04	\$8.40
Blueberry	000801-05	\$8.40

## "Piston Type" Air Valve Caps

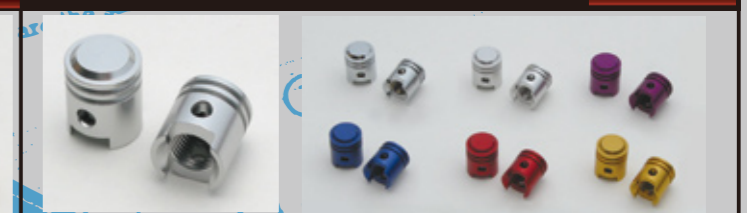

Color	Part #	Sug.Retail(2pc)
Chrome-Plated	000802	\$10.50
Blue	000802-01	\$9.45
Red	000802-02	\$9.45
Silver	000802-03	\$9.45
Gold	000802-04	\$9.45
Blueberry	000802-05	\$9.45

## "Hex" Air Valve Caps

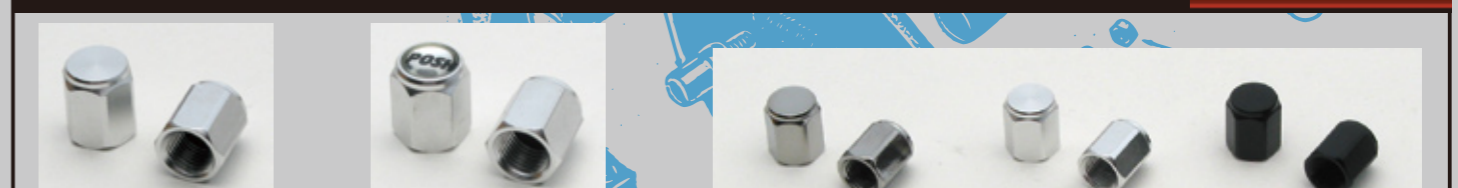

Standard			with POSH Budge		
Color	Part #	Sug.Retail(2pc)	Color	Part #	Sug.Retail(2pc)
Chrome-Plated	000804	\$9.45	Chrome-Plated	000803	\$11.55
Blue	000804-01	\$8.40	Blue	000803-01	\$10.50
Red	000804-02	\$8.40	Red	000803-02	\$10.50
Silver	000804-03	\$8.40	Silver	000803-03	\$10.50
Gold	000804-04	\$8.40	Gold	000803-04	\$10.50
Black	000804-06	\$8.40	Black	000803-06	\$10.50

## Grip Adhesive

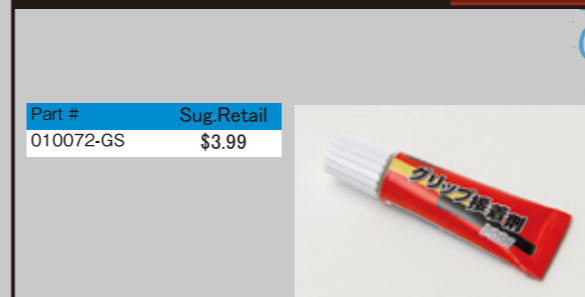

Part #	Sug.Retail
010072-GS	\$3.99

## Transparent Fuel Filter

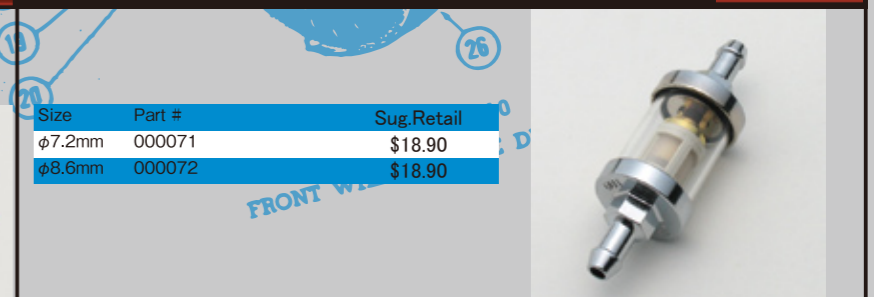

Size	Part #	Sug.Retail
φ7.2mm	000071	\$18.90
φ8.6mm	000072	\$18.90

### Stainless Steel Cap Bolt

MADE IN JAPAN



#### 6mm(5pc)

Size	Part #	pc	Sug.Retail
M6x10	900610-1S	5pc	\$3.15
M6x15	900615-1S	5pc	\$3.15
M6x20	900620-1S	5pc	\$3.67
M6x25	900625-1S	5pc	\$3.67
M6x30	900630-1S	5pc	\$3.67
M6x35	900635-1S	5pc	\$5.25
M6x40	900640-1S	5pc	\$5.25
M6x45	900645-1S	5pc	\$5.25
M6x50	900650-1S	5pc	\$6.82

#### 8mm(5pc)

Size	Part #	pc	Sug.Retail
M8x15	900815-1S	5pc	\$5.77
M8x20	900820-1S	5pc	\$5.77
M8x25	900825-1S	5pc	\$5.77
M8x30	900830-1S	5pc	\$5.77
M8x35	900835-1S	5pc	\$6.82
M8x40	900840-1S	5pc	\$6.82
M8x45	900845-1S	5pc	\$6.82
M8x50	900850-1S	5pc	\$7.87

#### 10mm(4pc)

Size	Part #	pc	Sug.Retail
M10x20(P-1.5)	901020-1S	4pc	\$6.30
M10x25(P-1.5)	901025-1S	4pc	\$6.30
M10x30(P-1.5)	901030-1S	4pc	\$6.30
M10x35(P-1.5)	901035-1S	4pc	\$7.87
M10x40(P-1.5)	901040-1S	4pc	\$7.87
M10x45(P-1.5)	901045-1S	4pc	\$7.87
M10x50(P-1.5)	901050-1S	4pc	\$8.92
M10x20(P-1.25)	911020-1S	4pc	\$8.92
M10x25(P-1.25)	911025-1S	4pc	\$8.92
M10x30(P-1.25)	911030-1S	4pc	\$10.50
M10x35(P-1.25)	911035-1S	4pc	\$10.50
M10x40(P-1.25)	911040-1S	4pc	\$11.55
M10x45(P-1.25)	911045-1S	4pc	\$12.60
M10x50(P-1.25)	911050-1S	4pc	\$13.65



### Flange Nut Set

MADE IN JAPAN

Size	Part #	pc	Sug.Retail
6mm	900026-1S	5pc	\$4.72
8mm	900028-1S	5pc	\$8.92
10mm(P-1.5)	900210-1S	4pc	\$8.92
10mm(P-1.25)	910210-1S	4pc	\$10.50



### Spring Washer Set

MADE IN JAPAN

Size	Part #	pc	Sug.Retail
6mm	900036-1S	5pc	\$3.67
8mm	900038-1S	5pc	\$4.20
10mm	900310-1S	5pc	\$5.25



### Rock Nut

MADE IN JAPAN

Size	Part #	pc	Sug.Retail
6mm	900056-1S	5pc	\$6.82
8mm	900058-1S	5pc	\$7.87
10mm(P-1.5)	900510-1S	4pc	\$10.50
10mm(P-1.25)	910510-1S	4pc	\$29.40



### Flat Washer Set

MADE IN JAPAN

Size	Part #	pc	Sug.Retail
6mm	900046-1S	5pc	\$3.15
8mm	900048-1S	5pc	\$3.67
10mm	900410-1S	5pc	\$4.20



### Stainless Steel Black Cap Bolt

MADE IN JAPAN



Size	Part #	pc	Sug.Retail
M6x10	900610-16	5pc	\$4.72
M6x15	900615-16	5pc	\$4.72
M6x20	900620-16	5pc	\$5.25
M6x25	900625-16	5pc	\$5.25
M6x30	900630-16	5pc	\$5.25
M6x35	900635-16	5pc	\$6.82
M6x40	900640-16	5pc	\$6.82
M6x45	900645-16	5pc	\$6.82
M6x50	900650-16	5pc	\$7.87

### H Shaped Rubber

MADE IN JAPAN



Size	Part #	pc	Sug.Retail
For M5 bolt	100201	2pc	\$4.72
For M6 bolt	100202	2pc	\$5.25
For M8 bolt	100203	2pc	\$5.77
For M6 bolt	100204	2pc	\$6.30
Only rubber	100205	2pc	\$5.25

### Universal Collar Set

MADE IN JAPAN

#### inner diameter 6mm x outer diameter 12.6mm

Thickness	Part #	Sug.Retail
1mm	100106	\$4.20(2pc)
3mm	100306	\$4.20(2pc)
5mm	100506	\$4.20(2pc)
8mm	100806	\$4.20(2pc)
10mm	101006	\$4.20(2pc)

#### inner diameter 8mm x outer diameter 17.0mm

Thickness	Part #	Sug.Retail
1mm	100108	\$4.72(2pc)
3mm	100308	\$4.72(2pc)
5mm	100508	\$4.72(2pc)
8mm	100808	\$4.72(2pc)
10mm	101008	\$4.72(2pc)



#### inner diameter 10mm x outer diameter 21.6mm

Thickness	Part #	Sug.Retail
1mm	100110	\$4.72(2pc)
3mm	100310	\$4.72(2pc)
5mm	100510	\$5.25(2pc)
8mm	100810	\$5.25(2pc)
10mm	101010	\$5.25(2pc)

#### inner diameter 12mm x outer diameter 25.6mm

Thickness	Part #	Sug.Retail
1mm	100112	\$5.25(2pc)
3mm	100312	\$5.25(2pc)
5mm	100512	\$5.77(2pc)
8mm	100812	\$5.77(2pc)
10mm	101012	\$5.77(2pc)

### Universal Collar Set (Long)

MADE IN JAPAN

#### inner diameter 6mm x outer diameter 12.6mm

Thickness	Part #	Sug.Retail
15mm	121506	\$4.41(2pc)
20mm	122006	\$4.41(2pc)
25mm	122506	\$4.72(2pc)
30mm	123006	\$4.72(2pc)

#### inner diameter 8mm x outer diameter 17.0mm

Thickness	Part #	Sug.Retail
15mm	121508	\$4.93(2pc)
20mm	122008	\$4.93(2pc)
25mm	122508	\$5.25(2pc)
30mm	123008	\$5.25(2pc)



#### inner diameter 10mm x outer diameter 21.5mm

Thickness	Part #	Sug.Retail
15mm	121510	\$5.25(2pc)
20mm	122010	\$5.25(2pc)
25mm	122510	\$5.77(2pc)
30mm	123010	\$5.77(2pc)

#### inner diameter 12mm x outer diameter 25.6mm

Thickness	Part #	Sug.Retail
15mm	121512	\$7.35(2pc)
20mm	122012	\$7.35(2pc)
25mm	122512	\$8.40(2pc)
30mm	123012	\$8.40(2pc)

### Stainless Steel Nut



Size	Part #	pc	Sug.Retail
M6	900066-1S	5pc	\$4.20
M8	900068-1S	5pc	\$5.25
M10(P-1.5)	900710-1S	4pc	\$6.82
M10(P-1.25)	910710-1S	4pc	\$7.87

### Poly-Carbonated Screen Screws

Size	Part#	Color	Pc	Sug.Retail
M5x10mm	990510	clear	10pc	\$6.30
M5x10mm	990510-06	black	10pc	\$8.40
M5x15mm	990515	clear	10pc	\$8.40
M5x15mm	990515-06	black	10pc	\$10.50
M5x20mm	990520	clear	10pc	\$10.50
M5x20mm	990520-06	black	10pc	\$12.60



### Universal Collar Set for Mechanic Use

#### inner diameter 6mm x outer diameter 12.6mm

Width	Part #	pc	Sug.Retail
1mm	300106	10pc	\$14.70
3mm	300306	10pc	\$14.70
5mm	300506	10pc	\$14.70
8mm	300806	10pc	\$14.70
10mm	301006	10pc	\$14.70

#### inner diameter 8mm x outer diameter 17.0mm

Width	Part #	pc	Sug.Retail
1mm	300108	10pc	\$16.80
3mm	300308	10pc	\$16.80
5mm	300508	10pc	\$16.80
8mm	300808	10pc	\$16.80
10mm	301008	10pc	\$16.80

#### inner diameter 10mm x outer diameter 21.5mm

Width	Part #	pc	Sug.Retail
1mm	300110	10pc	\$16.80
3mm	300310	10pc	\$16.80
5mm	300510	10pc	\$18.90
8mm	300810	10pc	\$18.90
10mm	301010	10pc	\$18.90



### Universal Rubber Collar Set

MADE IN JAPAN



Size	Part #	Sug.Retail
i.d 6x.o.d 20xw 4mm	100401	\$3.15(4pc)
i.d 8x.o.d 20xw 4mm	100402	\$4.20(4pc)
i.d 8x.o.d 25xw 4mm	100403	\$4.20(4pc)
i.d 8x.o.d 25xw 8mm	100404	\$5.25(4pc)
i.d 10x.o.d 20xw 4mm	100405	\$4.20(4pc)
i.d 10x.o.d 25xw 4mm	100406	\$4.20(4pc)
i.d 10x.o.d 25xw 8mm	100407	\$5.25(4pc)
i.d 4x.o.d 10xw 1mm	100408	\$2.62(4pc)
i.d 5x.o.d 12xw 1mm	100409	\$2.62(4pc)
i.d 6x.o.d 13xw 1mm	100410	\$2.62(4pc)
i.d 8x.o.d 18xw 1mm	100411	\$3.15(4pc)
i.d 10x.o.d 22xw 1mm	100412	\$3.15(4pc)

\*i.d=inner diameter o.d=outer diameter w=width